































Device Master Record

1. Bill of Materials
2. CAD Files
3. Drawings and Specifications
4. Assembly Instructions









1. Bill of Materials









Index	Subsystem	Part Number	Vendor	Nomenclature	Material	Dimensions	Quantity	Purpose	Image	Link
1	Frame	1515	8020	Footplate Support Beam	Aluminum	24"x1.5"x1.5"	2	Legs which connect the front and back caster wheels and provide wide footprint.		https://8020.net/1515.html
2	Frame	1515	8020	Steering Mechanism Connection Beam	Aluminum	24"x1.5"x1.5"	1	Center horizontal beam that connects the left and right castor wheel legs, and		https://8020.net/1515.html
3	Frame	1515	8020	Vertical Handrail Beam	Aluminum	23"x1.5"x1.5"	2	Vertical components of left and right arches that support the axle.		https://8020.net/1515.html
4	Frame	1515	8020	Vertical Axle Beam	Aluminum	12.25"x1.5"x1.5"	2	Vertical components of left and right arches that support the axle.		https://8020.net/1515.html
5	Frame	2426	8020	Base Plates	Aluminum	3.75" L x 3" W x 0.75"H	2	Base plates bolt to a profile end or side and is used to mount casters for added		https://8020.net/2426.html
6	Frame	3458	8020	Bolt Assemblies	Zinc	5/16-18 x .875" Screw, 5/16-18 Thread	34	Used for attaching brackets to the T-slots and L-slots.		https://8020.net/3458.html
7	Frame	4302	8020	L-Brackets	Aluminum	1"L x 1"H x 1" W	8	Used for fastening two T-slots at 90 degree angles.		https://8020.net/4302.html
8	Frame	B07PRQLP41	Amazon	T-Brackets	Aluminum	See image	2	Used for reinforcing T-slot connections at L-bracket joints to prevent pivotal motion		https://www.amazon.com/KOOTANS-Bracket-Connection-Aluminum-Profile/dp/B07PRQLP41/ref=asc_df_B07PRQLP41/?
9	Frame	B088BPVVR3	Amazon	Arch to Axle Wedges	PLA	1 kg Spool, 1.75 mm, Black, Pack of 1	1	Serves as stock for 3D printing wedges for the frame		https://www.amazon.com/HATCHBOX-3D-Filament-Dimensional-Accuracy/dp/B00J0ECR5I/ref=sr_1_3?dchild=1&keywords=PLA&qid=1619408811&sr=8-3
10	Frame	B088BPVVR3	Amazon	Arch to Axle Brackets Stock	Acrylic	12"x24"x0.25"	2	Serves as stock for laser cutting axle brackets for frame.		https://www.amazon.com/2-Pack-Clear-Acrylic-Sheet-Plexiglass/dp/B088BPVVR3/ref=sr_1_7?crid=3EB6MXTA9124X&dchild=1&keywords=acrylic+laser+sh
11	Frame	B01MSWYF8N	Amazon	Tray and Footplate Plywood	Wood	24" x 11.75" x 0.5"	2	Serves as stock for laser cutting footplate and tray for frame		https://www.amazon.com/Premium-Baltic-Birch-Plywood-Woodpeckers/dp/B01MSWYF8N/ref=sr_1_3?_encoding=UTF8&c=ts&dchild=1&keywords=Plywood&qid=1
12	Frame	B07QC9J3FK	Amazon	Long L-Bracket Angle Stock	Aluminum	11"x2"x2"x1/8"	2	Serves as stock for making size-adjustable static caster brackets for the frame.		https://www.amazon.com/JumpingBolt-Aluminum-Material-Surface-Scratches/dp/B07QC9J3FK/ref=sr_1_9?qclid=Cj0KCQiA1-





Index	Subsystem	Part Number	Vendor	Nomenclature	Material	Dimensions	Quantity	Purpose	Image	Link
1	Support	B009PXJGTY	Amazon	Kids Plastic Snow Sled	Plastic	46 x 19 x 4 inches	1	Rigid support to provide structure to the cushion body supports.		https://www.amazon.com/Lucky-Bums-Snow-Toboggan-48-Inch/dp/B009PXJGTY/ref=sr_1_21?dchild=1&keywords=Snow+Sled+plastic&qid=1614471917&s
2	Supports	B00T5VJDUK	Amazon	Foam Padding	Foam	72" L x 24" W x 3" H	1	Provides cushion and comfort at supports.		https://www.amazon.com/Foam-Touch-Upholstery-Cushion-Standard-Replacement/dp/B00T5VJDUK/ref=sr_1_4?keywords=padding+cushion&qid=1581677241&s=home-
3	Support	SRBS34PEW	Strapworks	Polypropylene Flat Webbing Strap Roll	Polyester Webbing	3/4" wide, 2' long	1	Main strap material for securing users in the supports.		https://www.strapworks.com/ProductDetails.asp?ProductCode=SRBS34PEW
4	Support	B07K68ZQ6H	Amazon	Adjustable Plastic Buckles	Nylon Webbing Straps	1 inch wide, 10 yard long	3	Main connection support component for securing users in the supports.		https://www.amazon.com/gp/product/B07K68ZQ6H/ref=ppx_yo_dt_b_asin_title_o0_1_s00?ie=UTF8&psc=1
5	Supports	B08CZZ967B	Amazon	Fabric Casing Material	Cotton	60x60"	2	Secures the foam padding to the support bases.		https://www.amazon.com/gp/product/B08CZZ967B/ref=ppx_yo_dt_b_asin_title_o0_7_s00?ie=UTF8&psc=1
6	Support	B00R2L3CX2	Amazon	Soft Seat Belt Covers	Sheepskin	10.24" x 6.57" x 1.61"	2	Provides cushion and comfort for supports.		https://www.amazon.com/gp/product/B00R2L3CX2/ref=ppx_yo_dt_b_asin_title_o0_0_s00?ie=UTF8&psc=1
7	Support	W0010BB00	Rope Master	Work Positioning Seat	Polyester Webbing	2' length x 6" wide x 2" depth	1	Rigid strap support to more security keep users in the stander		https://rope-master.com/en/seats/2995-565-seat-franklin-various-colors.html?SubmitCurrency=1&id_currency=3
8	Support	B072NCYVQK	Amazon	Carabiners	Aluminum	43x73mm	2	Works with Work Positioning Seat to keep users in stander		https://www.amazon.com/gp/product/B072NCYVQK/ref=ppx_yo_dt_b_asin_title_o0_1_s00?ie=UTF8&psc=1
9	Frame	1515	8020	Vertical Support Beam	1.50" X 1.50" T-Slotted Profile - Four Open T-Nuts	46"x1.5"x1.5"	1	Main verticle beam upon which user will primarily be supported.		https://8020.net/1515.html
10	Frame	B07Y5RJJRQ	Amazon	Support Bracket Stock	6061 aluminum	4" edge L, 1/8" thickness, 4' overall L	1	L-brackets		https://www.amazon.com/Aluminio-naranja-Extrusion-resistente-extruido/dp/B07Y5RJJRQ/ref=sr_1_21_sspa?dchild=1&keywords=angle+stock&qid=1588261105&sr=8-21-
11	Frame	11-8520	8020	Socket Head Cap Screw	Steel	M8 x 20mm	25	Used for attaching brackets to the T-slots.		https://8020.net/11-8520.html
12	Frame	13094	8020	Self-Aligning Roll-In T-Nut	Steel	16mm L x 11.8mm W	4	Used for attaching brackets to the T-slots.		https://8020.net/13094.html
13	Frame	B07KQ198NP	Amazon	Washer	Stainless Steel	1/4"	2	Creates tension in T-nuts		<a +washer&qid='1619421884&sr=8-3"' href="https://www.amazon.com/Stainless-Outside-Diameter-Bolt-Dropper/dp/B07KQ198NP/ref=sr_1_3?dchild=1&keywords=1%2F4">https://www.amazon.com/Stainless-Outside-Diameter-Bolt-Dropper/dp/B07KQ198NP/ref=sr_1_3?dchild=1&keywords=1%2F4"+washer&qid=1619421884&sr=8-3

















Index	Subsystem	Part Number	Vendor	Nomenclature	Material	Dimensions	Quantity	Purpose	Image	Link
1	Electronics	B01EWNUUUA	Amazon	ELEGOO MEGA 2560 R3 Board w/ USB	Electronic materials	5"x3"	1	Microcontroller for receiving user input from joystick and sending signals to the motor.		https://www.amazon.com/EL-KIT-008-Project-Complete-Ultimate-TUTORIAL/dp/B01EWNUUUA/ref=sr_1_2?dchild=1&keywords=ELEGOO%2BMEGA%2B2560%2BR3%2B5X3%2B5V%2B3V
2	Electronics	B01EWNUUUA	Amazon	Joystick Module for Arduino	Rubber-like joystick. Electronic	1"x1"x2" tall	1	Users will move the joystick to steer the stander. The joystick will be on top of lever and		https://www.amazon.com/EL-KIT-008-Project-Complete-Ultimate-TUTORIAL/dp/B01EWNUUUA/ref=sr_1_2?dchild=1&keywords=ELEGOO%2BMEGA%2B2560%2BR3%2B5X3%2B5V%2B3V
3	Electronics	B01EWNUUUA	Amazon	Miscellaneous Wires of Various Lengths	Copper	3"-6" in length	30	Connects the various electrical components together.		https://www.amazon.com/EL-KIT-008-Project-Complete-Ultimate-TUTORIAL/dp/B01EWNUUUA/ref=sr_1_2?dchild=1&keywords=ELEGOO%2BMEGA%2B2560%2BR3%2B5X3%2B5V%2B3V
4	Electronics	B07S9XZYN2	Amazon	High Torque Coreless Servo Motor	Copper & Aluminum / Stainless Steel	1.58 x 0.79 x 1.50 in	1	Rotates the free caster wheels after receiving signals from the microcontroller.		https://www.amazon.com/gp/product/B07S9XZYN2/ref=ppx_yo_dt_b_asin_title_o0_9_s00?ie=UTF8&pvc=1
5	Electronics	B07ZWC2VLX	Amazon	Electrical Tape	Electrical Tape	0.62 in X 49 ft	1	Insulates and organizes wires		https://www.amazon.com/Wapodeai-Electrical-Temperature-Resistance-Waterproof/dp/B07ZWC2VLX/ref=sr_1_1?dchild=1&keywords=electrical+tape&qid=1619422163&sr=8-1

Index	Subsystem	Part Number	Vendor	Nomenclature	Material	Dimensions	Quantity	Purpose	Image	Link
1	Steering	6061T6 SQUARE TUBE	Metal Supermarkets	Tube Stock	Aluminum	29x2"x1.5", 1/2" thick walls	1	Main structural container for the steering mechanism components		https://www.mchibsup.com/products/metal-supersmarkets/aluminum-6061-square-tube/
2	Steering	638K247	McMaster-Carr	Flanged Bearings	Steel	1/2" ID, 1.375" OD	4	Allows the steering mechanism to stay in place but still rotate. Will fit two		https://www.mcmaster.com/flanged-bearings/flanged-ball-bearing-1-1-2-shaft-diameter-3-8/ https://www.amazon.com/Prime-Line-5006678-Machine-Shop-Flanged-Bearing-1-1-2-Shaft-Diameter-3-8-Product-148492887Acrc3/
3	Steering	B074ZFP5C	Amazon	1/20 Bolts	Steel	1/20 bolts (about 3' long)	6	Connects the steering mechanism to the main frame		https://www.amazon.com/Shopless-Coupler-Diameter-Bolt-3-16-Diameter-1-1-2-Insert-20-Thread-3-8-Product-148492887Acrc3/
4	Steering	3458	8020	M8 bolts and nuts	Steel	1" M8 Bolts and Nuts	8	Secures the caster wheels to the caster bracket and tube		https://www.amazon.com/Shopless-Coupler-Diameter-Bolt-3-16-Diameter-1-1-2-Insert-20-Thread-3-8-Product-148492887Acrc3/
5	Steering	B07KG198NP	Amazon	Washers	Steel	1/2"	4	Creates extra tension for further securing the casters to the tube stock		https://www.amazon.com/Shopless-Coupler-Diameter-Bolt-3-16-Diameter-1-1-2-Insert-20-Thread-3-8-Product-148492887Acrc3/
6	Steering	B00084GU90	Amazon	Lock Nuts	Steel	1/2"	4	Creates extra tension for further securing the casters to the tube stock		https://www.amazon.com/Shopless-Coupler-Diameter-Bolt-3-16-Diameter-1-1-2-Insert-20-Thread-3-8-Product-148492887Acrc3/
7	Steering	B088BPVVR3	Amazon	Caster Sprocket Acrylic Sheet Stock	Acrylic	12"x24"x1/16"	1	Serves as stock for creating caster sprockets, which will directly transfer the rotation from the motor to the sprockets on the tube stock		https://www.amazon.com/Shopless-Coupler-Diameter-Bolt-3-16-Diameter-1-1-2-Insert-20-Thread-3-8-Product-148492887Acrc3/
8	Steering	B07NM75SBB	Amazon	Chain	Steel	75' of #35	1	Allows the customization of the lengths of chain.		https://www.amazon.com/Shopless-Coupler-Diameter-Bolt-3-16-Diameter-1-1-2-Insert-20-Thread-3-8-Product-148492887Acrc3/
9	Steering	B07NM75SBB	Amazon	Chain Master Links	Steel	#35 chain	2	Component of steering mechanism for transferring rotation from the motor to the sprockets		https://www.amazon.com/Shopless-Coupler-Diameter-Bolt-3-16-Diameter-1-1-2-Insert-20-Thread-3-8-Product-148492887Acrc3/
10	Steering	B079Z2RLF	Amazon	Sprocket w/ Set Screws	Steel	16 tooth #35 sprocket	2	Component of steering mechanism to allow counter-rotation between the two sprockets and connect to the motor.		https://www.amazon.com/Shopless-Coupler-Diameter-Bolt-3-16-Diameter-1-1-2-Insert-20-Thread-3-8-Product-148492887Acrc3/
11	Steering	B0052ICPD2	Amazon	Crown Gear w/ Set Screws	Steel	26 #35 Tooth	2	Rigid axle to hold the sprockets and connect to the motor.		https://www.amazon.com/Shopless-Coupler-Diameter-Bolt-3-16-Diameter-1-1-2-Insert-20-Thread-3-8-Product-148492887Acrc3/
12	Steering	8974K48	McMaster	Aluminum Shaft	Aluminum	24" long 1/2" diameter	1	Serves as stock for creating the brackets for the casters.		https://www.mcmaster.com/aluminum-shaft-stock/m/4source-6061-aluminum-rod-and-disc-7/
13	Steering	B07C9J3FK	Amazon	Steering Caster Bracket Stock	Aluminum	4" x 10" x 1/2"	2	These brackets will connect the free caster wheels rotate to steer the spider.		https://www.amazon.com/Shopless-Coupler-Diameter-Bolt-3-16-Diameter-1-1-2-Insert-20-Thread-3-8-Product-148492887Acrc3/
14	Steering	B077V016BJ	Amazon	Caster Wheel	Steel	4" radius wheel	2			https://www.amazon.com/Shopless-Coupler-Diameter-Bolt-3-16-Diameter-1-1-2-Insert-20-Thread-3-8-Product-148492887Acrc3/

Index	Subsystem	Part Number	Vendor	Nomenclature	Material	Dimensions	Quantity	Purpose	Image	Link
1	Box	B088BPVVR3	Amazon	Box Acrylic Stock	Acrylic	12"x24"x0.25"	1	Serves as stock for laser cutting the box for storing electronics.		https://www.amazon.com/2-Pack-Clear-Acrylic-Sheet-Plexiglass/dp/B088BPVVR3/ref=sr_1_7?crid=3EB6MXTA9124X&dchild=1&keywords=acrylic+laser+sh
2	Tray	11-8520	8020	Socket Head Cap Screw	Steel	M8 x 20mm	4	Used for attaching brackets to the T-slots and to hold up the tray.		https://8020.net/11-8520.html
3	Tray	13094	8020	Self-Aligning Roll-In T-Nut	Steel	16mm L x 11.8mm W	2	Used for attaching brackets to the T-slots and to hold up the tray.		https://8020.net/13094.html
4	Tray	13094	8020	M8 Hex nuts	Steel	M8	2	Used for attaching brackets to the T-slots and to hold up the tray.		https://8020.net/13094.html
5	Box	B08G8835G3	Amazon	M3 Hex Screws and Hex Nuts	Steel	10mm	3	Used to attach the microcontroller to the box		https://www.amazon.com/VIGRUE-570PCS-Stainless-Assortment-Machine/dp/B08H24W42K/ref=pd_sbs_1?pd_rd_w=44rh5&pf_rd_p=5e0f7f8d-f321-4a3e-bdac-
6	Box	B07PPNJCDK	Amazon	Wood Screws	Steel	5mm	4	Use to attach the box to the tray		https://www.amazon.com/gp/product/B07PPNJCDK/ref=ppx_yo_dt_b_asin_title_o02_s00?ie=UTF8&psc=1
7	Tray	B01MSWYF8N	Amazon	Wood Stock for Tray	Steel	11.75"x18"x1/2"	1	Used as stock to create the tray		https://www.amazon.com/Premium-Baltic-Birch-Plywood-Woodpeckers/dp/B01MSWYF8N/ref=sr_1_3?_encoding=UTF8&c=ts&dchild=1&keywords=Plywood&qid=1
8	Frame	4302	8020	L-Brackets	Aluminum	1"L x 1"H x 1" W	8	Used for fastening the tray to the T-slot at 90 degree angles.		https://8020.net/4302.html

Index	Subsystem	Part Number	Vendor	Nomenclature	Material	Dimensions	Quantity	Purpose	Image	Link
1	Frame	1UHK2	Grainger	Fixed Caster Wheels	Steel/Polyurethane Wheels	4 13/16" x 3" x 1 3/4"	2	Used to balance the stander and to allow the steering mechanism to function		https://www.grainger.com/product/1UHK2?ef_id=Cj0KCQjwgtWDBhDZARIsADEKwgPc5QN8HmWawk7di5Vo03UzW5kn5FojZiBV25ojNHdDoTDijJ_9kwkaAhsyEALw...
2	Frame	2426	8020	Base Plates	Aluminum	3.75" L x 3" W x 0.75"H	2	Used to connect the fixed casters to the frame.		https://8020.net/2426.html
3	Supports	1515	8020	Handrail Stock T-Slot	Aluminum	25"x1.5"x1.5"	1	Used to create handrails to allow patient transfer into the stander.		https://8020.net/1515.html
4	Supports	B07Q7S7Y44	Amazon	Pool Noodle	Turner Foam	6" length, 1" ID, 2" OD	2	Used to create soft grabable areas on the handrails.		https://www.amazon.com/gp/product/B07Q7S7Y44/ref=ppx_vo_dt_b_asin_title_o03_s00?ie=UTF8&psc=1
5	Frame	B07QC9J3FK	Amazon	Caster Bracket Stock	Aluminum	3" x 10" x 1/8"	1	Stock used to create a bracket that can adjust the distance that the static caster is from		https://www.amazon.com/JumpingBolt-Aluminum-Material-Surface-Scratches/dp/B07QC9J3FK/ref=sr_1_9?gclid=Cj0KCQiA-
6	Frame	3458	8020	Bolt Assemblies	Zinc	20mm 5/16-18 x .875" Screw, 5/16-18 Thread	38	Used for attaching brackets to the T-slots and L-slots.		https://8020.net/3458.html
7	Frame	4302	8020	L-Brackets	Aluminum	1"L x 1"H x 1" W	4	Used for fastening two T-slots at 90 degree angles.		https://8020.net/4302.html
8	Frame	B07PRQLP41	Amazon	T-Brackets	Aluminum	See image	6	Used for reinforcing T-slot connections at L-bracket joints to prevent pivotal motion		https://www.amazon.com/KOOTANS-Bracket-Connection-Aluminum-Profile/dp/B07PRQLP41/ref=asc_df_B07PRQLP41/?

Index	Subsystem	Part Number	Vendor	Nomenclature	Material	Dimensions	Quantity	Purpose	Image	Link
1	Wheel	D25-4224	Monster Scooter Parts	Wheelchair Wheel	Black Urethane tires	24" diameter, 1" thickness	2	Used as large wheels for stability and for the user to propel the stander.		https://www.monsterscooterparts.com/rear-wheel-drive-blue-streak-silver-sport-wheelchair.html?gclid=Cj0KCQjwgtWDBhDZARIsADEKwgMEH7vFRWQG_O
2	Axle	9056K33	McMaster	Aluminum Rod	Aluminum	4" length 0.75" Outer Diameter 0.5" Inner Diameter	2	Used as an adaptor component for connecting the wheel to the frame.		https://www.mcmaster.com/9056k36%2Fmultipurpose-6061-aluminum-round-tubes%2Fod~3-4%2Fid~1-2/multipurpose-6061-round-tubes/od~3-4/id~1-2/
3	Axle	8974K28	McMaster	Aluminum Rod	Aluminum	6.5" length 0.5" radius aluminum rod	2	Used as an adaptor component for connecting the wheel to the frame.		https://www.mcmaster.com/aluminum-shaft-stock/multipurpose-6061-aluminum-rods-and-discs-7/
4	Axle	9056k36	McMaster	Aluminum Rod	Aluminum	8" length 1" OD 0.75" ID Aluminum Rod	2	Used as a component for connecting the wheel to the frame. This is the main axle.		https://www.mcmaster.com/9056k36
5	Axle	B07PPNJCDK	Amazon	Wood Screw	Steel	10mm	2	Used to stabilize the adaptors between the wheel and the axle		https://www.amazon.com/gp/product/B07PPNJCDK/ref=ppx_yo_dt_b_asin_title_o02_s00?ie=UTF8&psc=1

Index	Subsystem	Part Number	Vendor	Nomenclature	Material	Dimensions	Quantity	Purpose	Image	Link
1	Kate Reed Lever	B07DFR5FFH	Amazon	Ball Bearings	Steel	5/16" diameter	16	Used in Kate Reed Lever to connect the adaptor component to the gear		https://www.amazon.com/PCN-0-3125-Precision-Chrome-Bearings/B07DFR5FFH/ref=pf_rd_p_r_1?dchild=1&keywords=5%3C
2	Kate Reed Lever	B08H24W42K	Amazon	M3 Button Head Screw Bolts and Hex Nuts	Steel	20mm	12	Used in Kate Reed Lever to connect the ratchet to the base component. Also used to allow		https://www.amazon.com/VIGRUE-572PCS-Stainless-Assortment-Machine/B08H24W42K/ref=pf_rd_p_r_1?dchild=1&keywords=5%3C
3	Kate Reed Lever	B08H24W42K	Amazon	M3 Button Head Screw Bolts and Hex Nuts	Steel	30mm	2	Used in Kate Reed Lever to connect the ratchet to the base component.		https://www.amazon.com/VIGRUE-572PCS-Stainless-Assortment-Machine/B08H24W42K/ref=pf_rd_p_r_1?dchild=1&keywords=5%3C
4	Kate Reed Lever	B08H24W42K	Amazon	M3 Button Head Screw Bolts and Hex Nuts	Steel	15mm	2	Used in the Kate Reed Lever to connect the base to the gear component.		https://www.amazon.com/VIGRUE-572PCS-Stainless-Assortment-Machine/B08H24W42K/ref=pf_rd_p_r_1?dchild=1&keywords=5%3C
5	Kate Reed Lever	B008RFVWU2	Amazon	Small Spring	Steel	0.25" radius, 0.5" length	2	Used to create tension to set the ratchet's main mode as 2 forward.		https://www.amazon.com/Prime-1-Line-Products-SP-9650-Extension-Op/B008RFVWU2/ref=pf_rd_p_r_1?dchild=1&keywords=5%3C
6	Kate Reed Lever	B07TP2VP2G	Amazon	Lever Bike Handle	Aluminum	6"x6"x1"	1	Used to allow the user to create tension to allow the ratchet to switch to reverse		https://www.amazon.com/GOYOTOP-Strength-Aluminum-Suitable-Mountain/B07TP2VP2G/ref=pf_rd_p_r_1?dchild=1&keywords=5%3C
7	Kate Reed Lever	B08JVDBBXT	Amazon	Lever Brake Cable	Steel	1mm diameter, 2' length	1	Used to connect the bike handle to the ratchet		https://www.amazon.com/Universal-Standard-Professional-Mountain-Accessories-Op/B08JVDBBXT/ref=pf_rd_p_r_1?dchild=1&keywords=5%3C
8	Kate Reed Lever	B07H52LJSW	Amazon	Knarp	Steel	M3 threaded	3	Used to create tension to allow the ratchet to switch to reverse 3 mode.		https://www.amazon.com/Rotary-Universal-Round-Throttle-Cables-Op/B07H52LJSW/ref=pf_rd_p_r_1?dchild=1&keywords=5%3C
9	Kate Reed Lever	B07FGVFN6F	Amazon	Bearings	Black Rubber Sealed Steel	8x22x7mm	2	Used to allow the gear component to spin.		https://www.amazon.com/Op/B07FGVFN6F/ref=pf_rd_p_r_1?dchild=1&keywords=5%3C
10	Kate Reed Lever	B06Y1WSSSD	Amazon	M4 Screws and Hex Nuts	Steel	20mm	4	Used to allow the gear component to spin, and to hold the spring in place.		https://www.amazon.com/Op/B06Y1WSSSD/ref=pf_rd_p_r_1?dchild=1&keywords=5%3C
11	Kate Reed Lever	8974K12	McMaster	Aluminum Rod	Aluminum	3' length 0.875" diameter	1	Used to connect the base component of the lever to the user. Also holes the brake		https://www.mcmaster.com/aluminum-shaft&stock/in/@purpose=6061-aluminum-rod-and-discs/7/
12	Kate Reed Lever	11-8520	8020	M8 Hex Screw and Hex Nut	Steel	10mm	2	Used to allow the gear component to spin.		https://8020.net/11-8520.html
13	Kate Reed Lever	B07SMZ74SH	Amazon	Rubber Bike Handle	Rubber Mushroom	6"x1" diameter	1	The user grips the bike handle. The brake handles are used to brake the wheels of the 2 stander.		https://www.amazon.com/JOY-Handlebar-Non-Slip-Mushroom-Tricycle-Op/B07SMZ74SH/ref=pf_rd_p_r_1?dchild=1&keywords=5%3C
14	Brakes	B08J3RQ2FC	Amazon	Brake Handle	Aluminum	6"x6"x1"	2	The wood screw secures the brake handles on the 2 aluminum rod.		https://www.amazon.com/Complete-Hybrid-Cables-Callipers-Levers-Op/B08J3RQ2FC/ref=pf_rd_p_r_1?dchild=1&keywords=5%3C
15	Brakes	B07PPNJCDK	Amazon	Wood Screw	Steel	10mm	2	The wood screw secures the brake handles on the 2 aluminum rod.		https://www.amazon.com/Op/B07PPNJCDK/ref=pf_rd_p_r_1?dchild=1&keywords=5%3C
16	Brakes	B08J3RQ2FC	Amazon	Brake Cable	Steel	1mm diameter, 2' length	2	Connects the brake handle to the 2 brakes.		https://www.amazon.com/Complete-Hybrid-Cables-Callipers-Levers-Op/B08J3RQ2FC/ref=pf_rd_p_r_1?dchild=1&keywords=5%3C
17	Brakes	B074Z2FPSC	Amazon	1/2-20 Hex Screw	Steel	3"	1	Connects the brake handles to the 1 aluminum rod		https://www.amazon.com/Prime-Line-500678-Machine-Slotter-Op/B074Z2FPSC/ref=pf_rd_p_r_1?dchild=1&keywords=5%3C
18	Brakes	B0008PEPNW	Amazon	1/2-20 Hex Nut	Steel	1/2-20	2	Connects the brake handles to the 2 aluminum rod.		https://www.amazon.com/Hillman-150003-Coarse-Thread-Pieces-Op/B0008PEPNW/ref=pf_rd_p_r_1?dchild=1&keywords=5%3C

2. CAD Files

(see additional zip file)

3. Drawings and Specifications

2

1

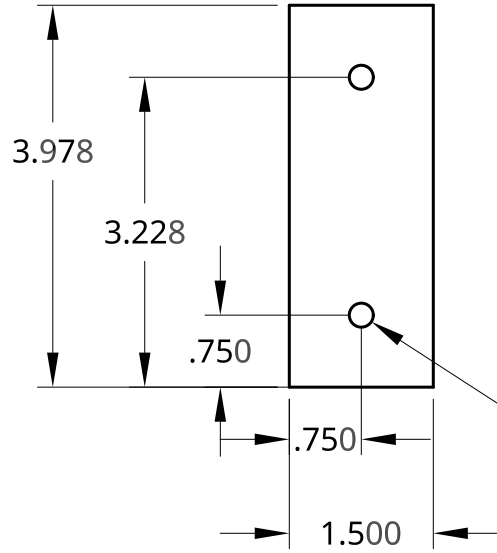
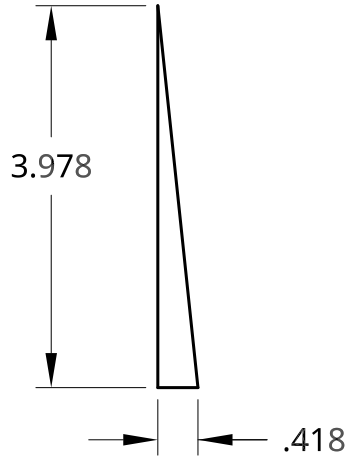

Ø.250
TYP



B

B

A

A

UNLESS OTHERWISE SPECIFIED, DIMENSIONS ARE IN INCHES .XX = ±.0- .XXX = ±.00- .XXXX = ±.000- SURFACE FINISH	DRAWN	NAME NYELI KRATZ	DATE 03/03/2020	TITLE Arch_to_axle_wedge_v3	
	CHECKED				
	APPROVED				
	DO NOT SCALE DRAWING				
BREAK ALL SHARP EDGES AND REMOVE BURRS THIRD ANGLE PROJECTION 	MATERIAL	FINISH	SIZE A	DWG NO.	REV.
			SCALE 1:2	WEIGHT	SHEET 1 of 1

2

1

2

1

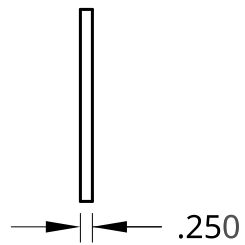
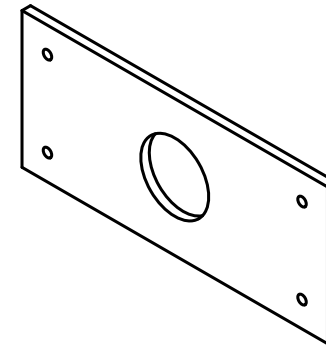
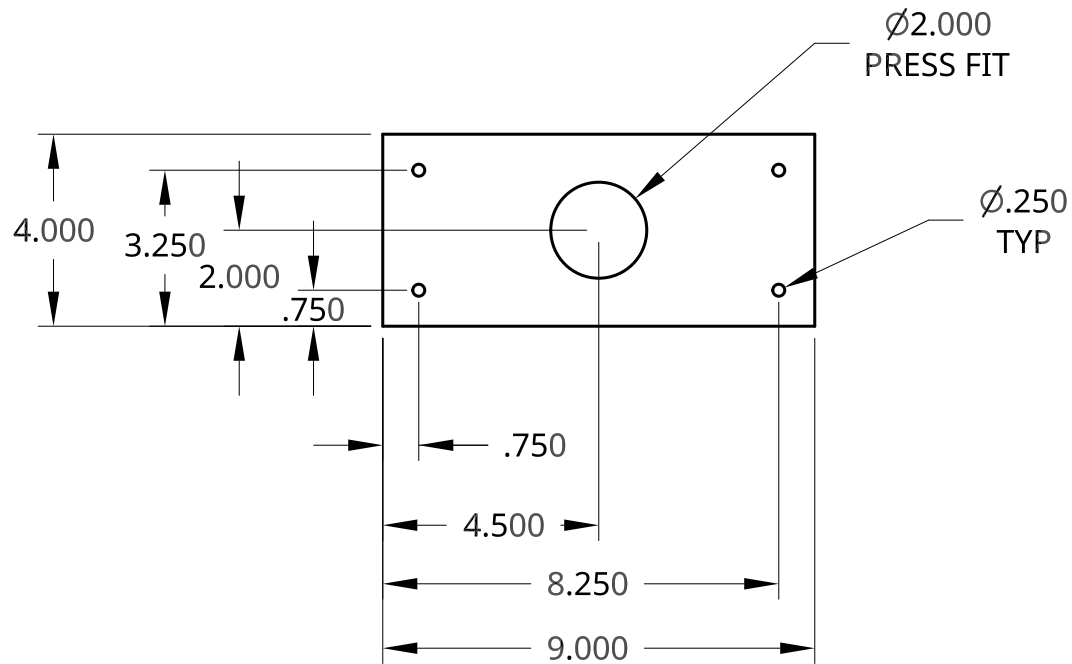

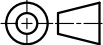
UNLESS OTHERWISE SPECIFIED, DIMENSIONS ARE IN INCHES .XX = ±.0- .XXX = ±.00- .XXXX = ±.000- SURFACE FINISH $\sqrt{\quad}$ DO NOT SCALE DRAWING BREAK ALL SHARP EDGES AND REMOVE BURRS THIRD ANGLE PROJECTION 		NAME	DATE		
	DRAWN	NYELI KRATZ	03/03/2020	TITLE	
	CHECKED			Arch to axle bracket v2	
	APPROVED				
	MATERIAL	FINISH	SIZE	DWG NO.	REV.
			A		
			SCALE 1:4	WEIGHT	SHEET 1 of 1

2

1

B

B

A

A

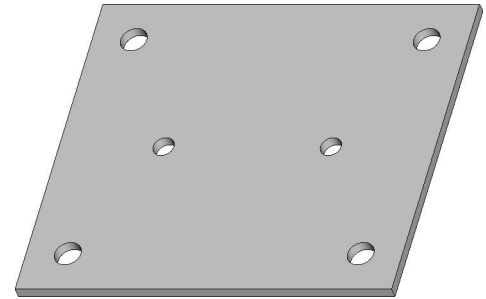
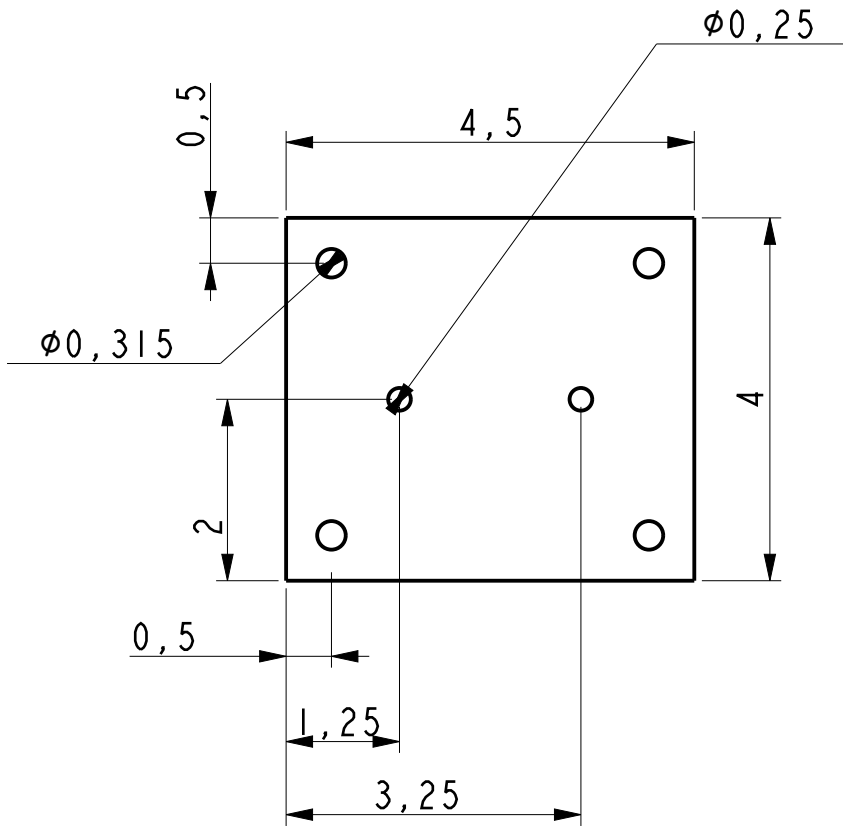

Team UNIstand

TITLE

caster_brackets.drw

SIZE

A

CAGE CODE

DWG NO

REV

SCALE: 12,000

UNIT WT: [.2]

SHEET 1 OF 1

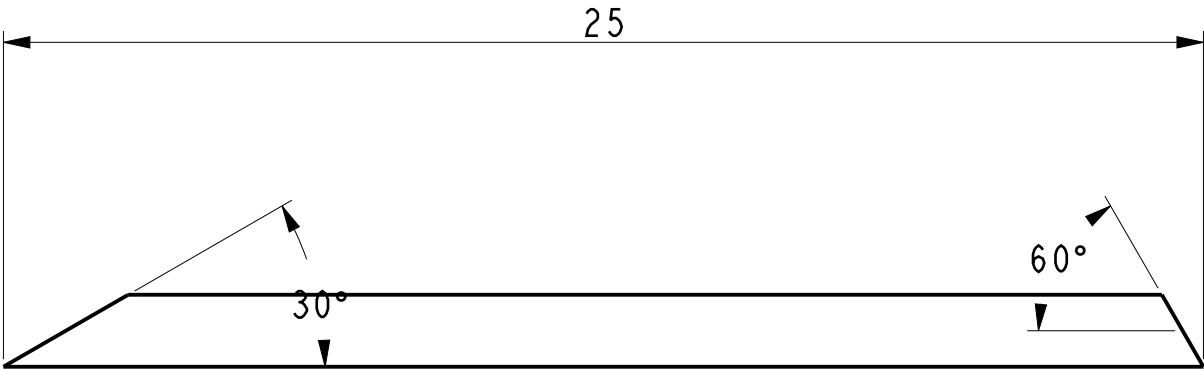

Team UNIstand

TITLE

handrail.drw

SIZE	CAGE CODE	DWG NO	REV
A			
SCALE: 0,250		UNIT WT: [.2]	SHEET 1 OF 1

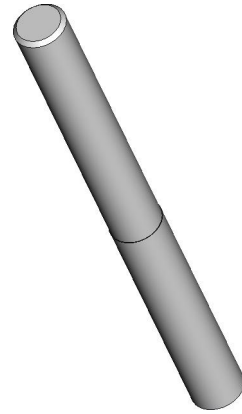
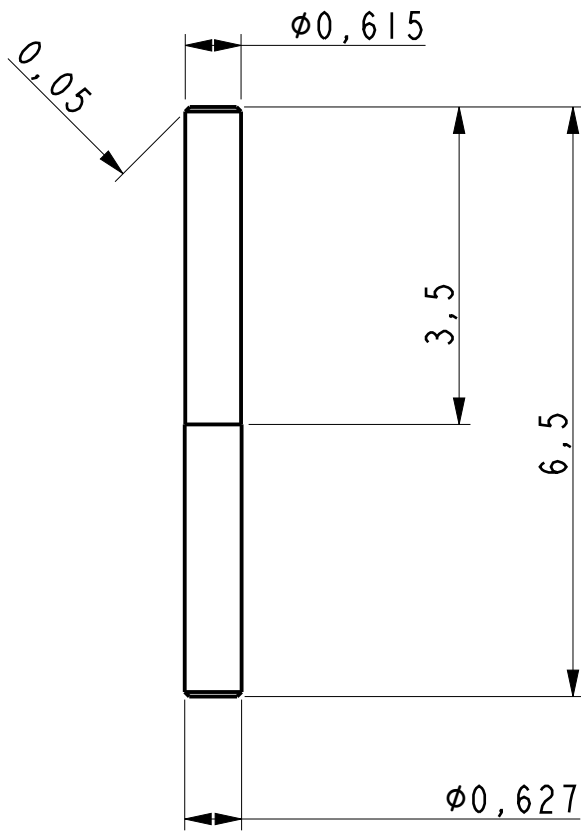

Team UNIstand

TITLE

shafts.drw

SIZE

CAGE CODE

DWG NO

REV

A

SCALE: 12,000

UNIT WT: [.2]

SHEET 1 OF 1

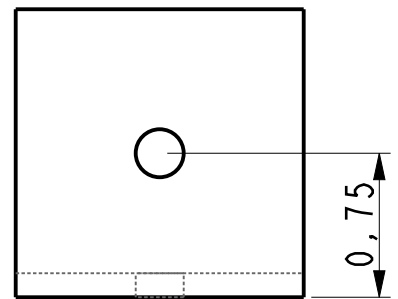
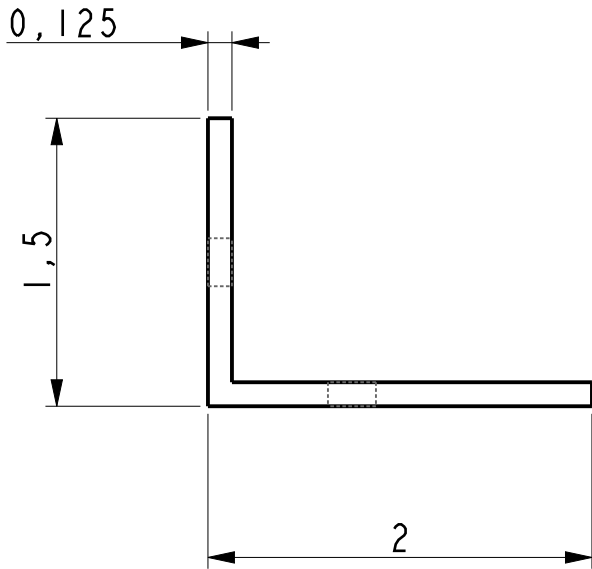
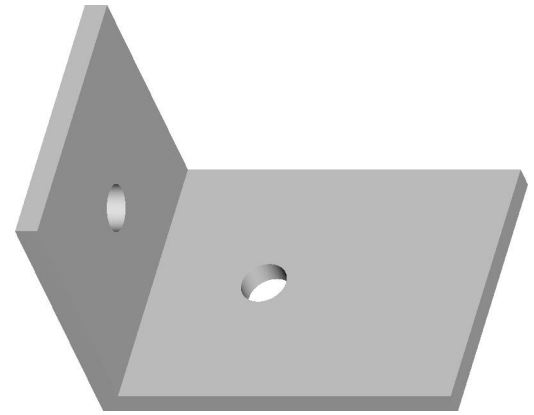
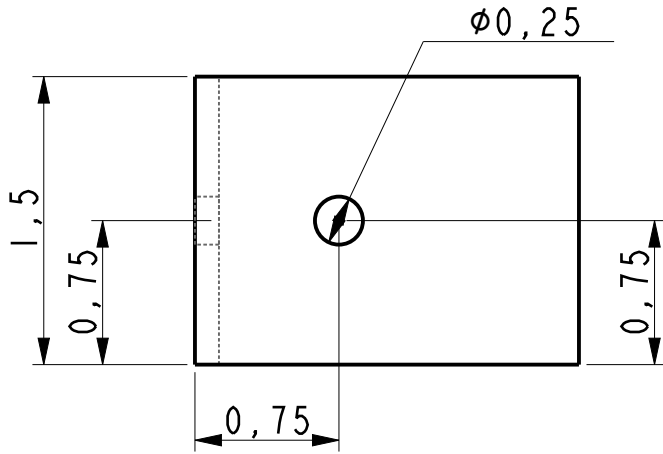

Team UNIstand

TITLE

support_bracket.drw

SIZE

CAGE CODE

DWG NO

REV

A

SCALE: 1,000

UNIT WT: [.2]

SHEET 1 OF 1

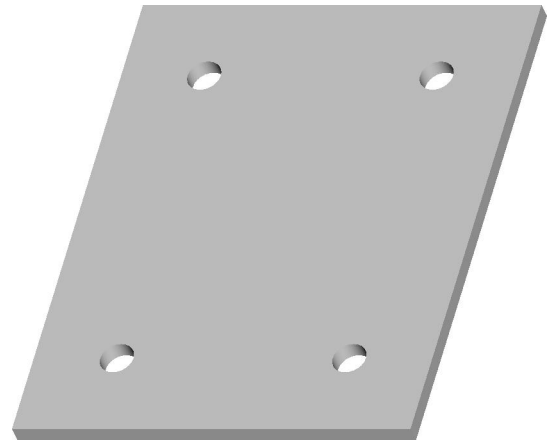
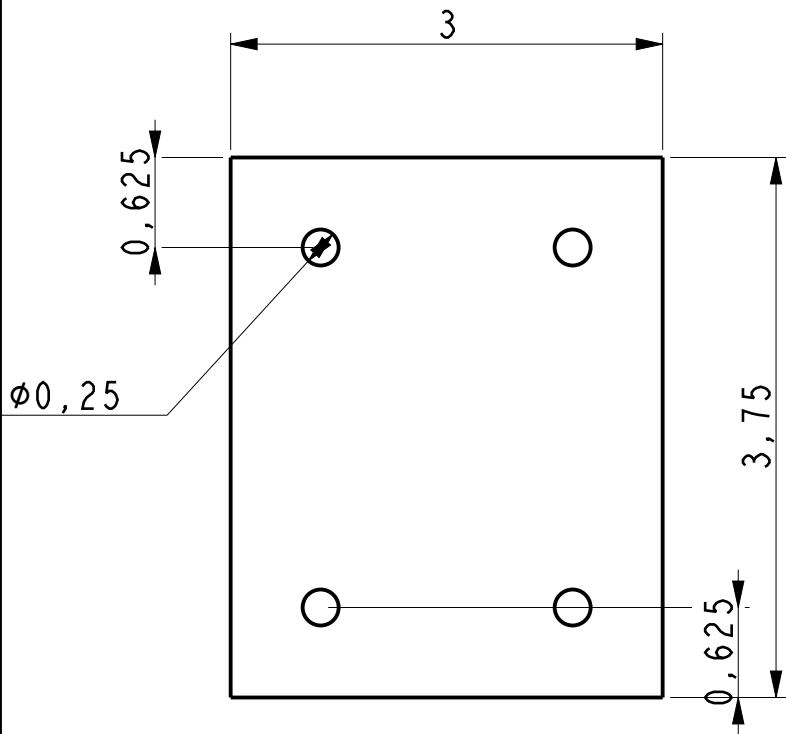

Team UNIstand			
TITLE			
fixed_caster_bracket.drw			
SIZE	CAGE CODE	DWG NO	REV
A			
SCALE: 0,750	UNIT WT: [.2]	SHEET 1 OF 1	

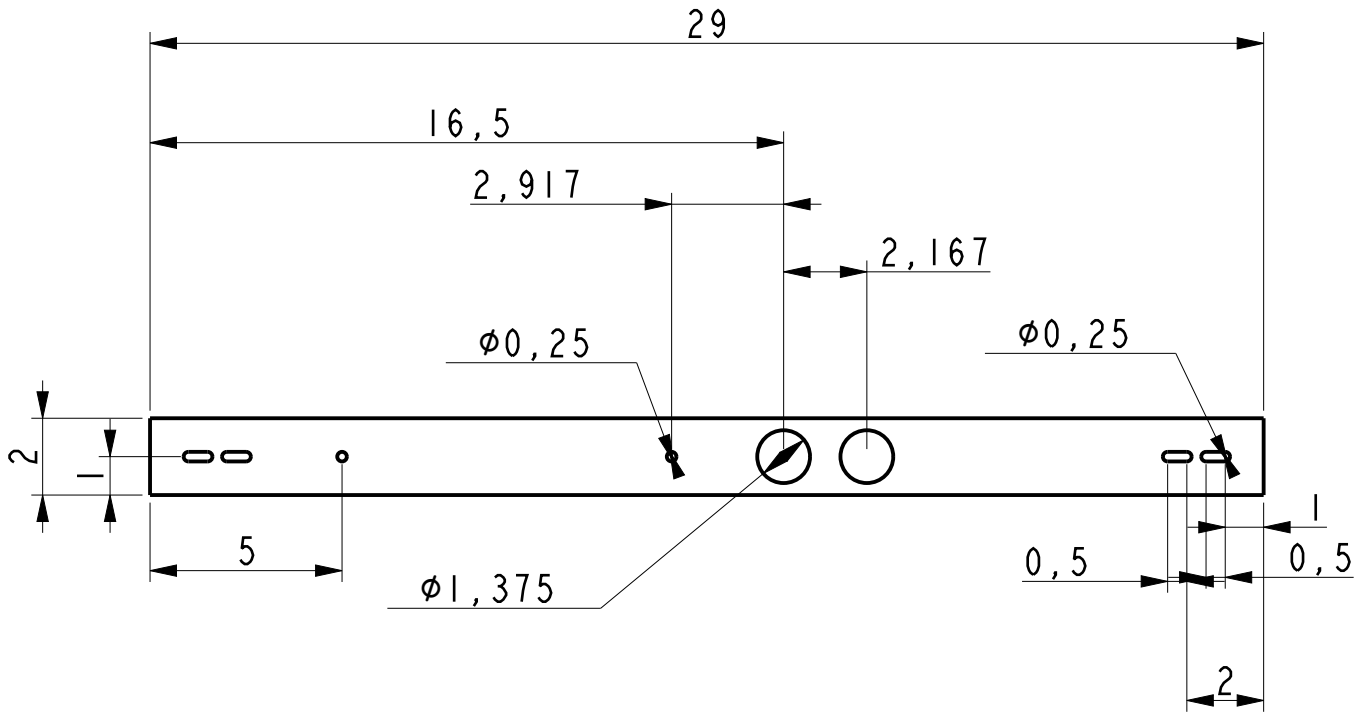

Team UNIstand

TITLE

tube_part.drw

SIZE

CAGE CODE

DWG NO

REV

A

SCALE: 0,200

UNIT WT: [.2]

SHEET 1 OF 1

4. Assembly Instructions

(#) indicates a part index from the *1.1 Frame Assembly Bill of Materials*.

MATERIALS:

1. 2 Footplate Support Beams 24"x1.5"x1.5" T-Slot (1)
2. 1 Steering Mechanism Connection Beam 24"x1.5"x1.5" T-Slot (2)
3. 2 Vertical Handrail Beam 23"x1.5"x1.5" T-Slot (3)
4. 2 Vertical Axle Beam 12.25"x1.5"x1.5" T-Slots (4)
5. 2 Base Plates (5)
6. 34 Bolt Assemblies (6)
7. 8 L-Brackets (7)
8. 2 T-Brackets (8)
9. 4 Arch to Axle Wedges (9)
10. 2 Arch to Axle Brackets stock: 12"x24"x0.25" acrylic sheet (10)
11. 2 tray and footplate 24" x 11.75" x 0.5" plywood (11)
12. 2 Long L-Bracket angle stock 11"x2"x2"x1/8" (12)

MACHINING:

Arch to Axle Wedges

1. Using the 2.3.2 *Arch to Axle Wedges Drawings & Specifications* document and a 3D printer, print 4 Arch to Axle Wedges.

Arch to Axle Brackets

1. Using the 2.3.3 *Arch to Axle Bracket Drawings & Specifications* document and 0.25" thick acrylic, laser cut 2 Arch to Axle Brackets.

Fixed Caster brackets

1. Use a horizontal bandsaw and drill press to machine the 3" x 10" x 1/8" aluminum sheet as specified in 3.2.7 *Fixed Caster Bracket Drawings & Specifications*.

ASSEMBLY:

1. Drill 4 holes of $\frac{1}{4}$ " diameter in footplate $\frac{3}{4}$ " from the shorter edge and 1" from the longer edge at each corner of the footplate. Attach the wood board loosely to the footplate support beams by sliding t nuts into the 80/20 slots and putting screws through the holes you drilled in the footplate.

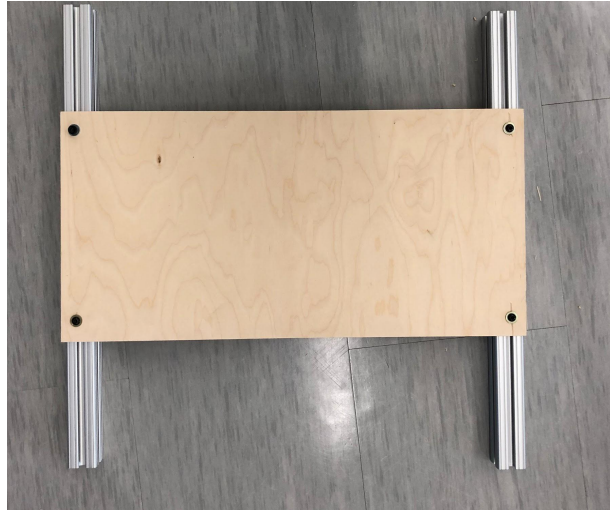

2. Slide the footplate to the end of the pieces of 80/20. Lay the propulsion connection beam on top of the other pieces directly above the footplate as shown below (do not attach the L-brackets shown in this picture). Then loosen the footplate bolts and slide the footplate back so that it is in line with the back edge of the footplate support beams.

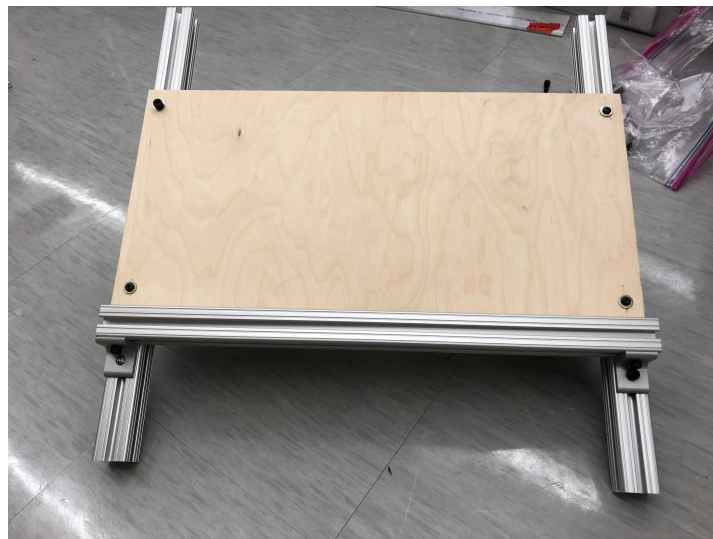

3. Use L-brackets and t-brackets with $\frac{1}{4}$ -20 bolts and t-nuts as shown below to fasten the vertical handrail beam and the vertical axle beam to the footplate support beams on each

side of the footplate. Attach the vertical handrail beam to the propulsion connection beam as shown to the left as well as attaching it to the footplate support beam and loosely attach the vertical arch beam at the end of the footplate support beam as shown to the right. Use one t-bracket and two L-brackets for the vertical axle beam (right) and two L-brackets to the vertical handrail beam (left).

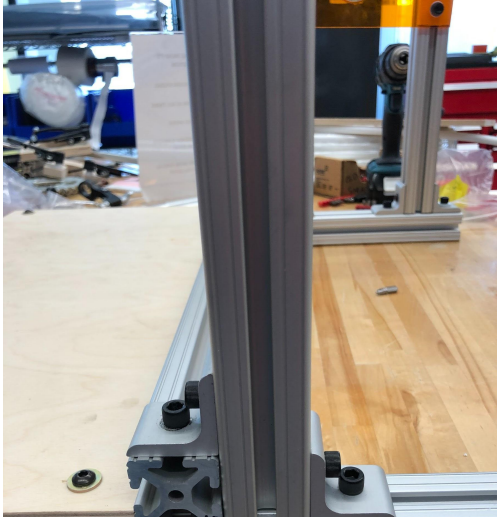

4. Press the 2" OD 1" ID flanged bearing into the large hole in the Arch to Axle Bracket so that the flange is facing away from the stander. Put $\frac{1}{4}$ -20 bolts through each of the holes and slide the wedge on over the screws. Loosely attach t-nuts to the end of the screws and slide the t-nuts down the vertical handrail beam and vertical axle beam and tighten the bolts when the top of the wedge is flush with the top of the vertical arch beam as shown below.



5. Remove the propulsion connection beam by loosening the t-nuts in the L-brackets which connect it to the vertical 24" long pieces of t-slot. This will make it easier to attach the steering mechanism to the frame. Then use M8 screws to attach the base plates to the footplate support beams as shown below. We will attach the fixed caster wheels here later.



(#) indicates a part index from the *2.1 Supports Assembly Bill of Materials*.

MATERIALS:

1. 1 Kids Plastic Snow Sled 48" (1)
2. 1 High Density Cushion Mattress Topper 2" x 24" x 72" (2)
3. 1 Polypropylene Flat Webbing Strap Roll (3)
4. 3 Adjustable Plastic Buckles (4)
5. 2 Large Fabric Sheets (5)
6. 2 Soft Seat Belt Covers (6)
7. 1 Work Positioning Seat (7)
8. 2 Carabiners (8)
9. 1 Vertical Support beam: 1.5" x 1.5" x 42" 80/20 t-slot. (9)
10. Support bracket stock: 4 inches of aluminum angle stock 2" x 2" x 1/8" (10)
11. 4 Bolts (11)
12. 4 T-nuts (12)
13. 2 Washers (13)

MACHINING

Support Brackets

1. Use a horizontal bandsaw to cut down the support bracket stock into two 1.5" long pieces as specified in *3.2.6 Support Bracket Drawings & Specifications* document.
2. Use a vertical bandsaw to shorten one of the legs of the L down to 1.5" as specified in *3.2.6 Support Bracket Drawings & Specifications* document.
3. Use a drill press to drill 1/4" diameter holes as specified in *3.2.6 Support Bracket Drawings & Specifications* document.

Main support

1. Cut off the top of the sled so that it is 36" long.
2. Drill 2 holes along the center axis of the sled where the 80/20 support beam will be attached.
3. Place the sled on the mattress topper and trace along the sides of the sled. Repeat on the other side of the mattress topper.
4. Cut the mattress topper on the outline of the sled. Ensure it is an appropriate fit for the sled, and cut down if necessary.
5. Place the sled back on the mattress topper and mark on the mattress topper where the 4 pre-existing side holes of the sled are.
6. Cut slits through the mattress topper where each of these holes are marked.
7. Along both the left and right edges of the sled, cut an additional slot midway between the 2 side holes where the support straps will be attached.

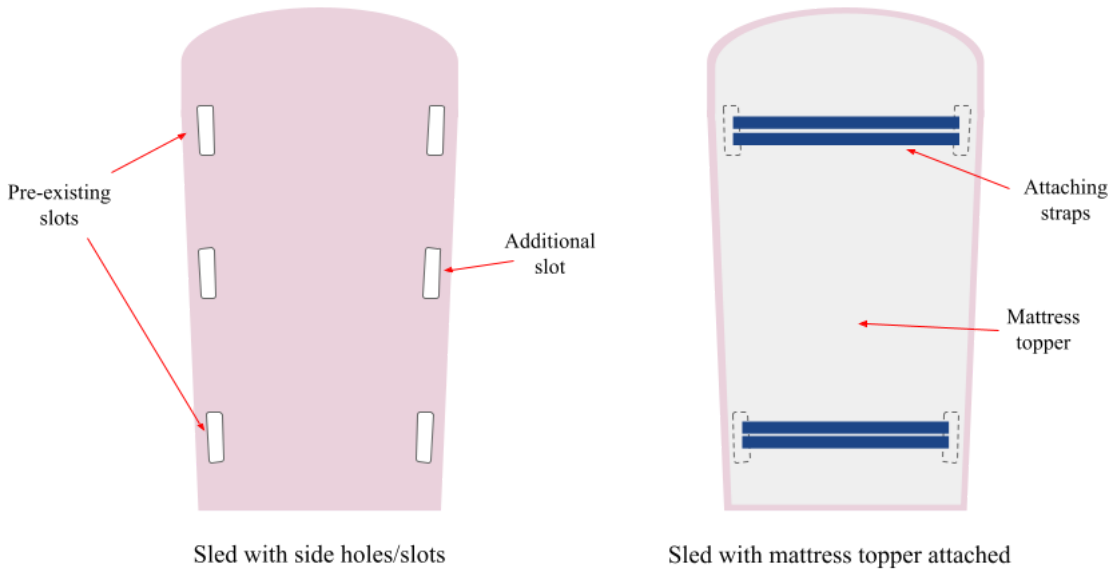

ASSEMBLY

1. Take the polypropylene webbing strap and thread it through the bottom left slit. The mattress topper should be aligned to the sled, allowing the strap to be threaded through the hole in the sled.
2. Thread strap through the sled hole and mattress topper slit parallel (bottom right). Ensure that the strap is pulled tightly. Secure strap to sled.
3. Repeat steps 1-2 for each slit.
4. Take the polypropylene webbing strap and thread it through the bottom left sled hole. Secure one end to the sled and add the male part of a plastic buckle to the other end. Repeat for the other 2 sled holes on the left side.
5. Take the polypropylene webbing strap and thread it through the bottom right sled hole. Secure one end to the sled and add the female part of a plastic buckle to the other end. Repeat for the other 2 sled holes on the right side.
6. Sew two fabric sheets together and fit over the sled. Finish stitching so that the fabric is well-fitted to the sled and secure. (optional: Add a zipper to easily slip on/off the cover.)
7. Cut holes in the fabric cover and pull the support straps out.
8. Attach soft seat belt covers to the upper 2 support straps.
9. Use carabiners to attach the work positioning seat to the 2 middle sled holes.
10. Using the holes drilled previously, attach the 2 brackets to the sled. For each bracket, insert a screw from outside the fabric cover, place a washer between the fabric and the sled, and secure using a T-nut between the sled and the mattress topper. Make sure one bracket is facing left and the other is facing right.
11. Attach the vertical support beam to the bracket using the 2 remaining screws and T-nuts.
12. Attach two L-brackets to the left and right sides of the base of the vertical support beam, using M8 bolts and T-nuts to secure them as shown below.

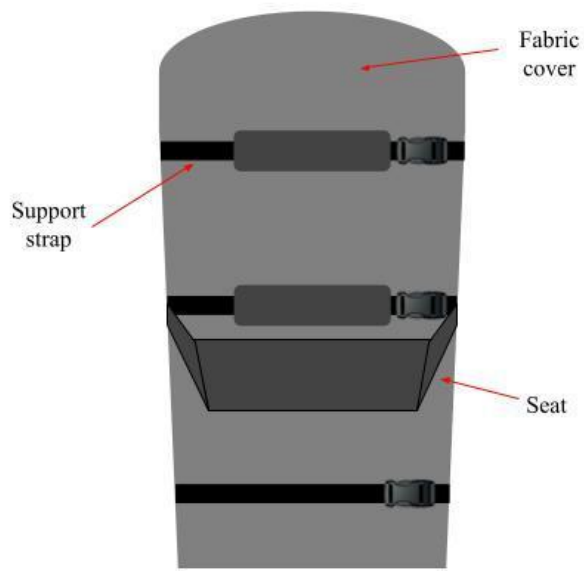

Support with fabric + straps (*front*)

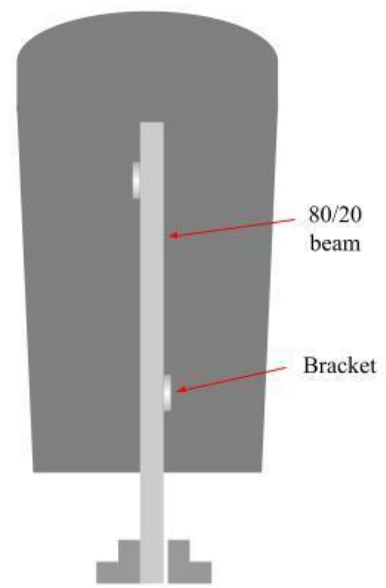

Support with 80/20 beam (*back*)

(#) indicates a part index from the *4.1 Steering Mechanism Assembly Bill of Materials*.

MATERIALS:

1. Tube part stock: 1 aluminum tube 29"x2"x1.5", 1/8" thick walls. (1)
2. 4 5/8" ID, 1.375"OD flanged bearings. (2)
3. 6 long 1/4-20 bolts (about 3" long). (3)
4. 8 short M8 bolts and nuts (about 1" long). (4)
5. 4 1/4" washers. (5)
6. 4 1/4" lock nuts. (6)
7. 12"x24"x3/16" thick acrylic sheet. (7)
8. 75" of #35 chain. (8)
9. 2 #35 chain master links (9)
10. 16 tooth sprocket with set screws (10)
11. 26 Tooth Crown Gear - 12 DP/14.5 PA with set screws (11)
12. Aluminum Shaft stock: 24" long 3/4" diameter aluminum rod (12)
13. Steering Caster Bracket stock: 4" x 10" x 1/8" aluminum sheet. (13)

MACHINING:

Steering Caster Bracket

1. Use a horizontal bandsaw to cut the 4" x 10" x 1/8" aluminum sheet down into two pieces of 4.5" length as specified in *3.2.3 Steer Caster Brackets Drawings & Specifications*.
2. Use a drill press to drill holes in the aluminum rectangles as specified in *3.2.3 Steer Caster Brackets Drawings & Specifications*.

Caster sprockets

1. Using the *2.2.1 Low Sprocket .svg* document and 3/16" thick acrylic, laser cut the low sprocket part.
2. Using the *2.2.2 High Sprocket .svg* document and 3/16" thick acrylic, laser cut the low sprocket part.

Tube part

1. Using the *3.2.8 Tube Part Drawings & Specifications* document and 1/8" thick 1.5x2x36" rectangular tube stock, drill the 0.25" diameter holes at the locations specified in the drawings using a drill press or mill.
2. Use a mill to drill press fit holes for the 1.375" OD bearings at specified locations in the drawing.
3. Use a mill to create the slots as specified in the *Tube Part Drawings & Specifications* document.

Shafts

1. Using $\frac{3}{4}$ " diameter aluminum rod shaft, use a lathe to cut down the stock into two 6" long shafts and machine them according to the *3.2.5 Shafts Drawings & Specifications*.
2. Use the lathe to turn down the shaft to the diameters specified in *3.2.5 Shafts Drawings & Specifications*.

Servo adaptor

1. 3D print the servo to shaft adaptor according to *2.2.3 Servo Adaptor .stl* file in the CAD files folder.

ASSEMBLY:

1. Machine the tube part.
2. Press fit flanged bearings into each 1.375" hole on each side of the tube part.
3. Use 2 long $\frac{1}{4}$ -20 screws to attach the caster brackets to the slots at the each end of the tube stock as shown below.

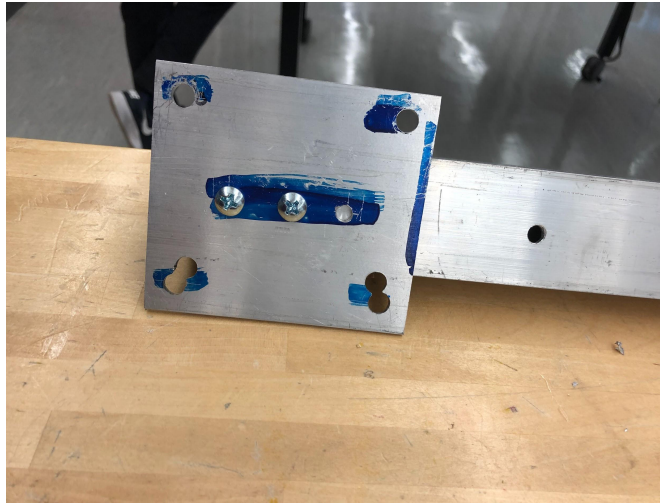

4. Use a wrench to remove the caster wheel from its axle and attach the caster hub to the steering caster bracket using 4 M8 screws with washers as shown below.

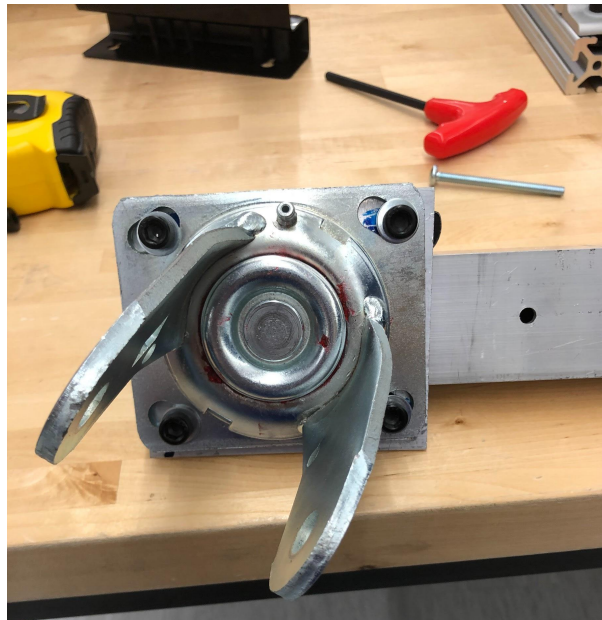

5. Repeat steps 7-8 on the opposite end of the tube part as shown below.



6. Press the aluminum shafts into the bearings in the tube part using a mallet so that about 1/2" is through the tube in the side opposite that of the caster hubs.



7. Slide one caster sprocket over each caster hub as shown below.

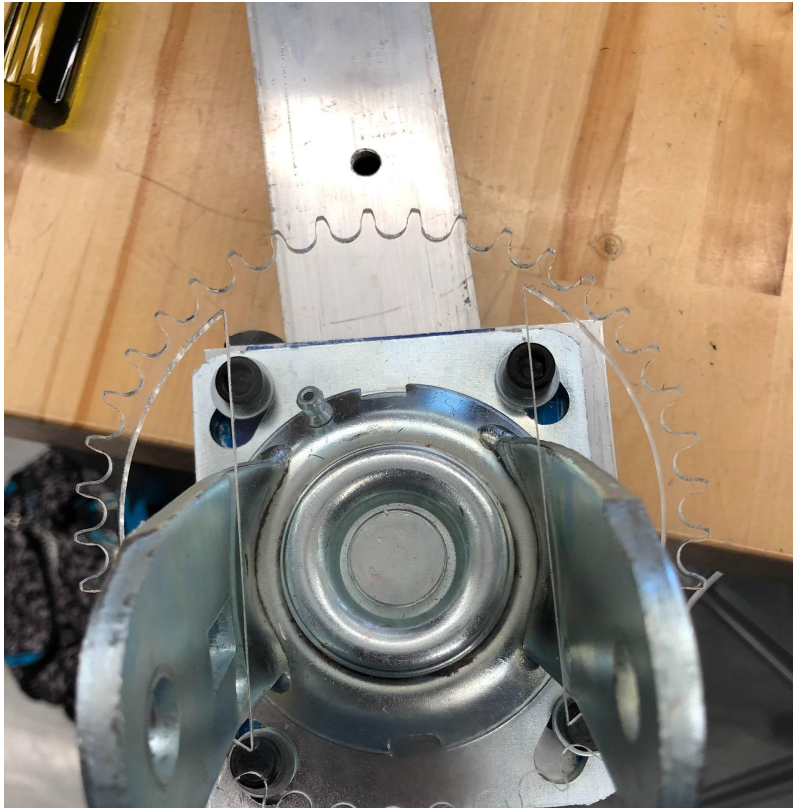

8. Use hot glue to secure the caster sprocket to the caster hub as shown below, making sure that the caster sprocket is centered about the axis of rotation of the swivel caster.



- Slide the 16-tooth sprockets and then the gears onto the aluminum shafts as shown below, using their set screws to fix them in place.

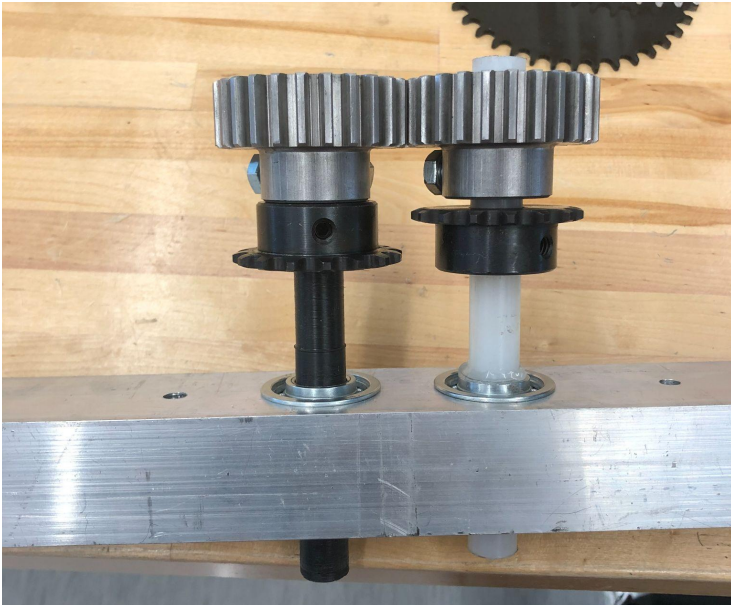

- The full steering mechanism should now look like this:



- Now loosen the set screw on the sprockets and use the chain to help align the height of the 16-tooth sprocket with the steering caster acrylic sprocket. Once the chain is parallel to the tube part when tensioned, as shown below, tighten the set screws.

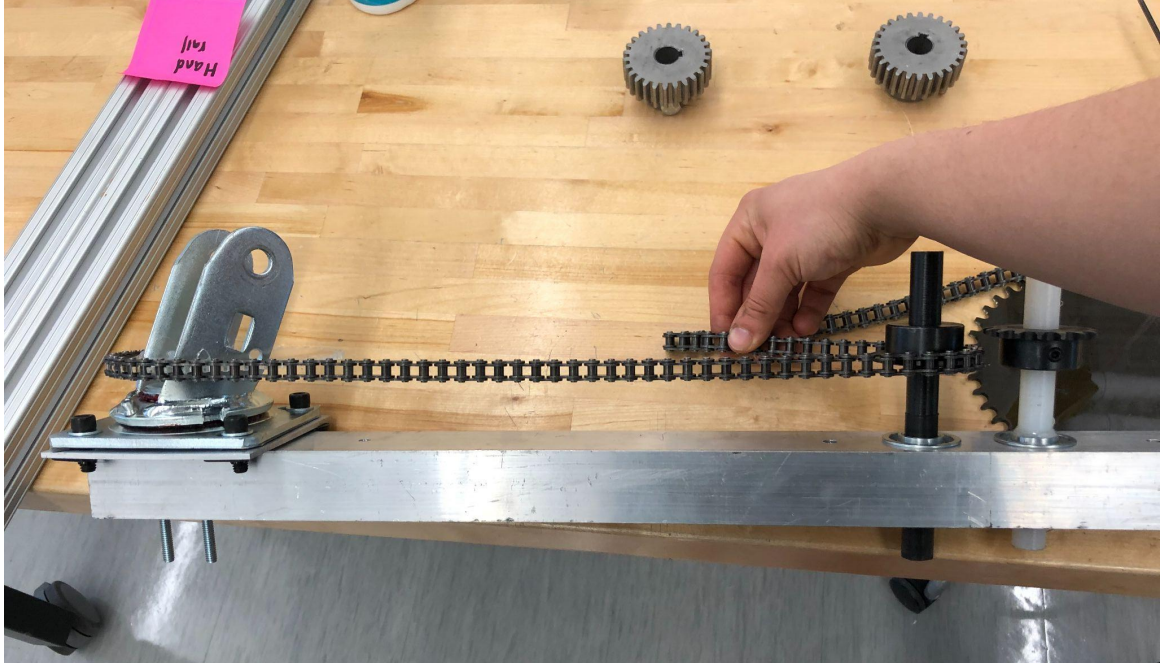

12. Now use a chain breaker and master links to shorten the chain to fit around the sprockets loosely on each side as shown below.



13. Loosen the lock washers on the caster bracket to tube part connection screws and push the caster hubs back in those slots to tension the chain.

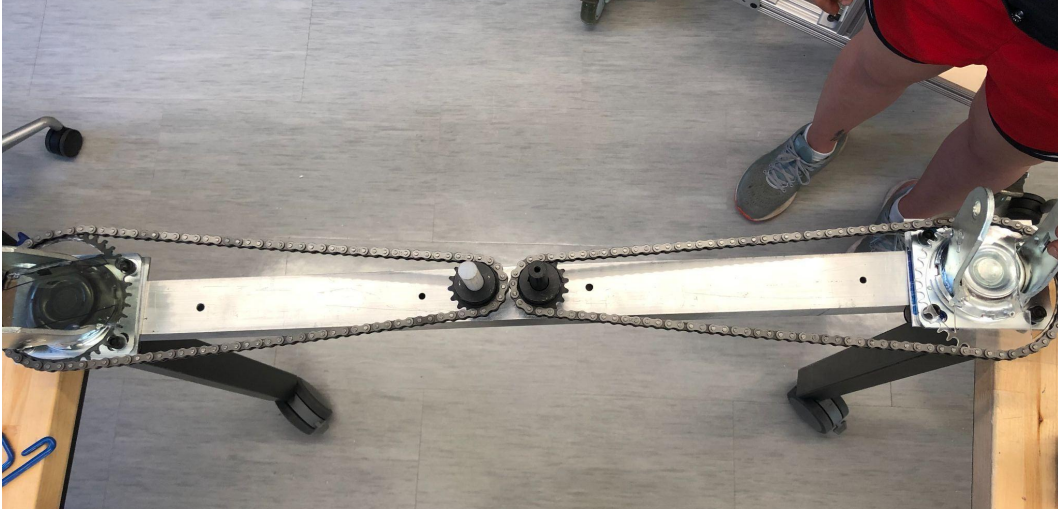

14. Return the caster wheels to their hub using two adjustable wrenches. Then use the servo adaptor part to attach the servo motor to the aluminum shaft on the longer side of the tube part as shown below to complete the steering mechanism.

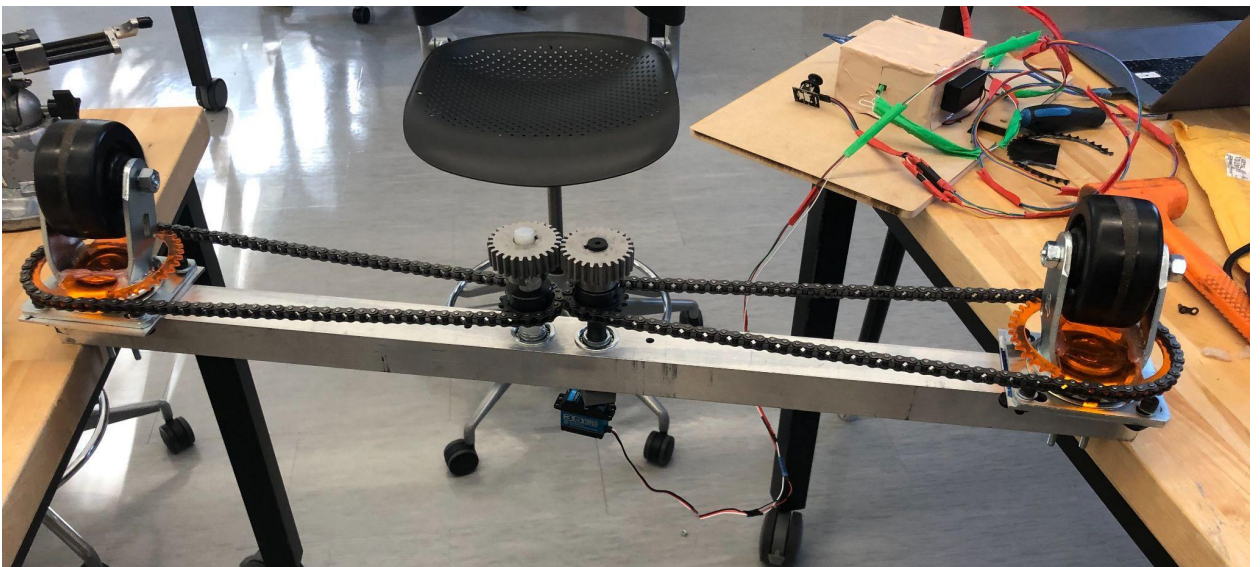

(#) indicates a part index from the *3.1 Electronics Assembly Bill of Materials*.

MATERIALS:

1. ELEGOO MEGA 2560 R3 Board w/ USB (1)
2. Joystick Module for Arduino (2)
3. Miscellaneous Wires of lengths (3)
4. High Torque Coreless Servo Motor (4)
5. Electrical Tape (5)

MACHINING:

1. It may be necessary to solder wires together to create longer wires. It will be necessary to obtain 7 wires of at least 5 ft long, and 2 wires of at least 6" long.
2. Upload the below code onto the ELEGOO MEGA 2560 R3 Board.

```
#include <Servo.h>
#define SERVO_PIN 9
#define XJOY_PIN A1 //X axis reading from joystick will go into analog pin A1
#define direct -1
Servo myservo ;

void setup()
{
  Serial.begin(9600);
  myservo.attach(9);
}

int prevValue = 31;

void loop()
{
  delay(50);
  int joystickXVal = analogRead(XJOY_PIN) ; //read joystick input on pin A1
  Serial.print(joystickXVal); //print the value from A1
  Serial.println(" = input from joystick"); //print "=input from joystick" next to the value
  prevValue = max(0,min(prevValue + direct*(((joystickXVal-503))/20),270));
  Serial.print(prevValue);
  Serial.println(" = output to servo"); //print "=output to servo" next to the value
  Serial.println();
  myservo.write(prevValue); //write the calculated value to the servo
}
```

ASSEMBLY:

1. Attach the lengthened wires as indicated in the below diagram to connect the joystick, motor, and power source.

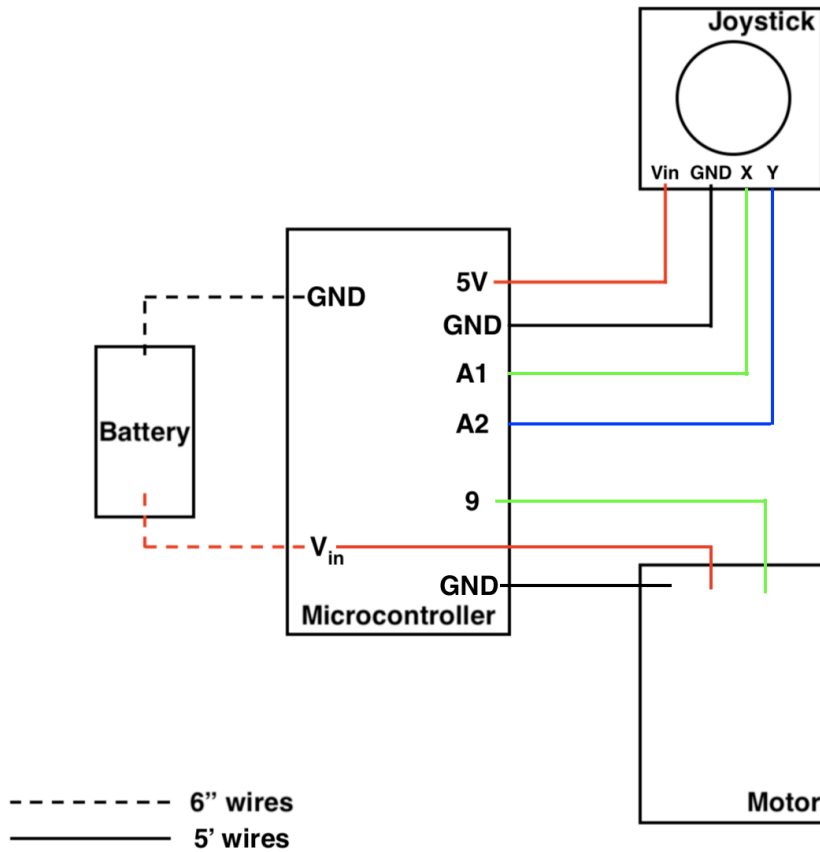

2. Cover the wires in electrical tape to ensure insulation between wires. Then use the electrical tape to organize the separate connections to the joystick, to the motor, and to the power source.

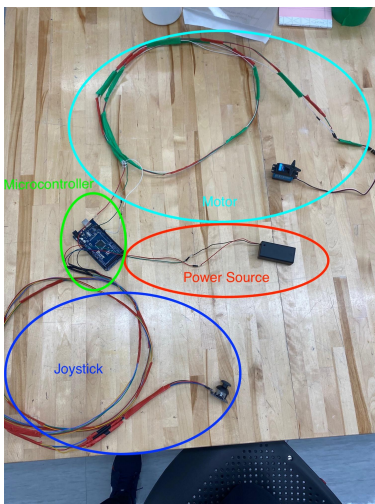

(#) indicates a part index from the *5.1 Tray and Electronics Casing Assembly Bill of Materials*.

MATERIALS:

1. 3.5mm 36"x36" Acrylic (1)
2. 4x 20mm M8 screws (2)
3. 2x M8 T-Nuts (3)
4. 2x M8 hex nuts (4)
5. 3x M3 hex screws and hex nuts (5)
6. 4x 5mm Wood Screws (6)
7. Tray stock: 11.75"x18"x½" plywood (7)
8. 2 L-brackets (8)

MACHINING:

Box

1. Use a laser cutter to cut the six parts from *2.2.7 Electronic Box Cad Files* from 3.5mm 36"x36" Acrylic.

Tray

1. Use a laser cutter to produce the tray as specified in *2.2.4 Tray CAD Files* from 11.75"x18"x½" plywood.

ASSEMBLY:

1. Attach the top part of the box to the tray using 5mm wood screws as indicated by the small holes in the figure below. Then, drill large M8 holes as indicated by the large holes in the figure below.

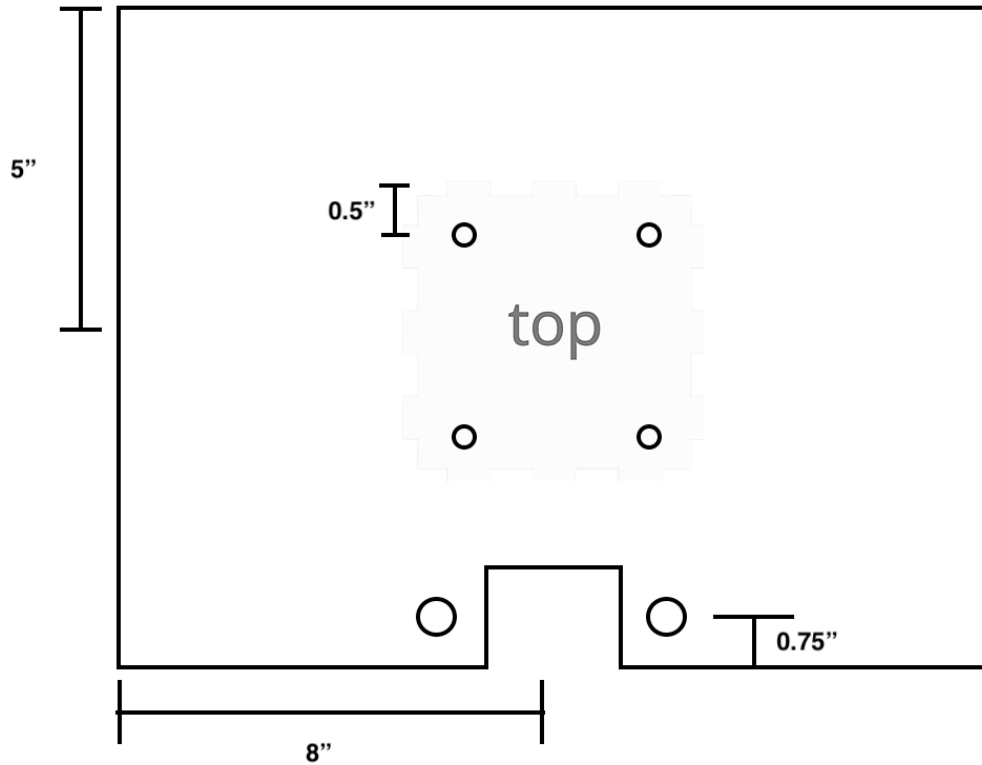

2. Attach the microcontroller from the *3.4 Electronic Assembly Instructions* onto the bottom part of the box as shown below using M3 hex screws and hex nuts. Drill any necessary holes into the bottom part of the box.

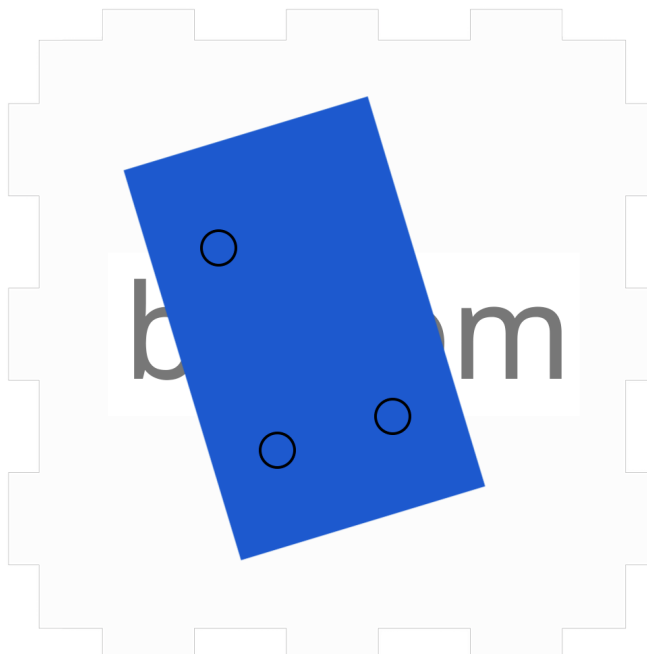

3. Drill M8 holes into the center of the right, left, and back parts of the box, which will act as outgoing connections.
4. Fit the wires and connections from *3.4 Electronic Assembly Instructions* through the holes, and then assemble the six sides of the box in the following manner below. Use super glue to connect the individual components. Then super glue the power source onto the back of the box.

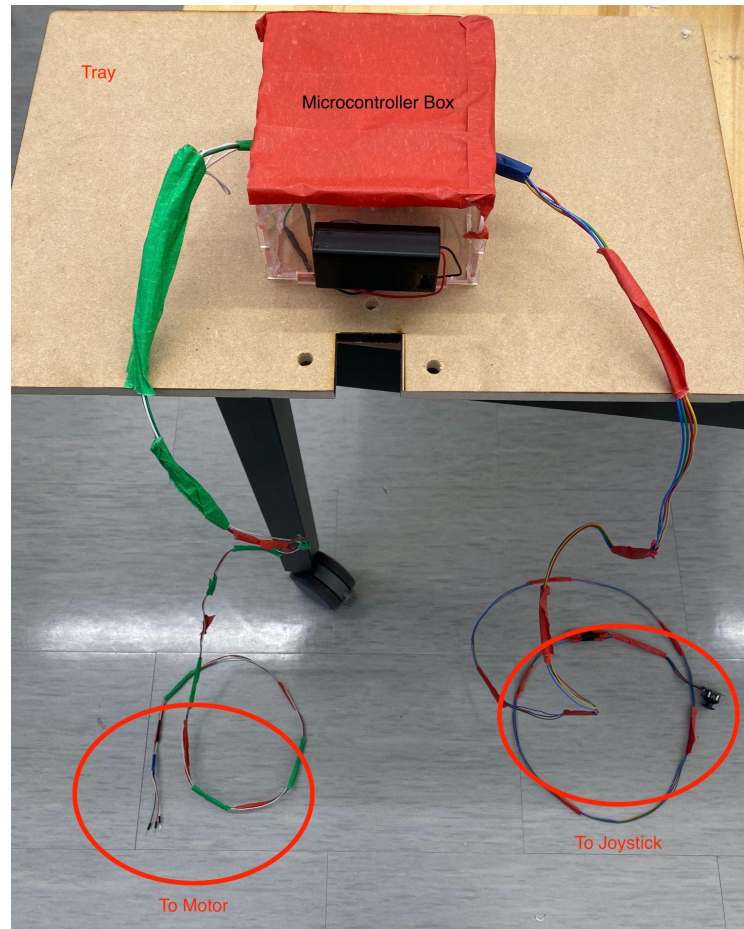

5. Fit M8 screws through the M8 holes in the tray and the L-brackets. Then attach the L-brackets to the tray on the same side as the box, putting t-nuts and M8 hex nuts on the other side of the L-brackets.

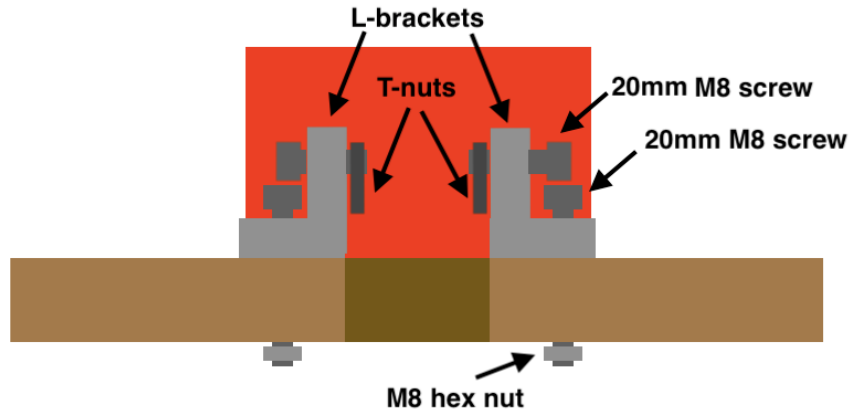

(#) indicates a part index from the *6.1 Final Assembly Bill of Materials*.

COMPONENTS/MATERIALS

1. 2 Fixed Caster Wheels (1)
2. 2 Baseplates (2)
3. Frame subassembly (3)
4. Steering mechanism subassembly (4)
5. Wheel subassembly (5)
6. Electronics subassembly (6)
7. Tray subassembly (7)
8. Handrail stock 25"x1.5"x1.5" T-Slots (8)
9. 2 6" long pool noodles (9)
10. Fixed caster brackets 3" x 10" x 1/8" aluminum sheet. (10)
11. 38 M8 Bolt Assemblies (11)
12. 4 L-Brackets (12)
13. 6 T-Brackets (13)

MACHINING

Fixed Caster Brackets:

1. Use a horizontal bandsaw to cut the 3" x 10" x 1/8" aluminum sheet down into two pieces of 3.75" length as specified in *3.2.7 Fixed Caster Brackets Drawings & Specifications*.
2. Use a drill press to drill holes in the aluminum rectangles as specified in *3.2.7 Fixed Caster Brackets Drawings & Specifications*.

Handrails:

1. Use a chop saw to cut the handrail stock 25"x1.5"x1.5" T-Slots at an angle as specified in *3.2.4 Handrail Drawings & Specifications*.
2. Cut a 6" pool noodle through one slide length-wise. Slide the pool noodle onto the handrails.
3. Use a bolt assembly to attach an L-bracket to the Handrail and slide it below the pool noodle on the side closer to the 60 angle specified in *3.2.4 Handrail Drawings & Specifications*. This will keep the pool noodle in place.

(#) indicates a part index from the *7.1 Wheel Assembly Bill of Materials*.

COMPONENTS/MATERIALS

1. 2x 24" Wheelchair Wheel (1)
2. Wheel Adaptor Materials (either):
 - a. 3D Printing Capabilities
 - b. 2x4" length 0.75" Outer Diameter 0.5" Inner Diameter aluminum rod, (2)
2x6.5" length 0.5" aluminum rod. (3)
3. 2x 8" length 1" OD 0.75" ID Aluminum Rod (4)
4. 2x 10mm Wood Screw (5)

MACHINING

1. Wheel Adaptor (either):
 - a. 3D print *2.2.5 Axle Adaptors CAD Files* using PLA
 - b. Lathe the 2x6" length 0.5" aluminum in accordance to the specifications in *3.2.5 Shafts Drawings and Specifications*.

ASSEMBLY

1. Fit the small wheel adaptor into the large wheel adaptor in the direction as indicated below.



2. Fit the large adaptor side into the 8" length 1" OD 0.75" ID Aluminum Rod. Drill the 10mm wood screw into the large aluminum rod, large adaptor, and small wheel adaptor while all the rods are combined. This can be done by first drilling a small hole through the aluminum rod and both adaptors and then screwing the wood screw into the hole. This will keep the whole system together.



3. Fit the combined adaptor system through the bearings of the wheel, with the small adaptor side in front.



4. Repeat steps 1-3 to prepare another wheel.

(#) indicates a part index from the *8.1 Lever Assembly Bill of Materials*.

COMPONENTS/MATERIALS

Kate Reed

1. 16x 5/16" Ball Bearings (1)
2. 12x 20mm M3 Button Head Screw Bolts and Hex Nuts (2)
3. 2x 30mm M3 Head Screw and Hex Nut (3)
4. 2x 15mm M3 Button Head Screw Bolts and Hex Nuts (4)
5. 2x Small Spring (5)
6. 1x Lever Bike Handle (6)
7. 1x Brake Cable (7)
8. 3x Knarp (8)
9. 2x 8x22x7mm Bearings (9)
10. 4x 20mm M4 Screws and Hex Nuts (10)
11. 1x 3' 0.875" diameter 6061 Aluminum Rod (11)
12. 2x 10mm M8 Hex Screw and Hex Nut (12)
13. 1x Rubber Bike Handle (13)

Modifications for Brakes

14. 2x Brake Handle (14)
15. 2x 10mm Wood Screw (15)
16. 2x Brake Cable (16)
17. 1x 3" 1/4-20 Hex Screw (17)
18. 2x 1/4-20 Hex Nut (18)

MACHINING

Brake Holder

1. 3D Print the STL file in *2.2.6 Brake Holder CAD Files* using TPU 95A.

ASSEMBLY

Kate Reed

1. Assemble the left and/or right handed lever as noted in the Hackaday Website <https://hackaday.io/project/7221-hand-drive>



Brake Modifications

1. In order to fit the brake handles to the lever, it will be necessary to drill a hole through both brake handle adaptors and the aluminum rod. This hole should fit a $\frac{1}{4}$ -20 Hex Screw.



2. Tighten the first Brake handle on using the $\frac{1}{4}$ -20 Screw and Hex Nut, as shown in the first image below. Then screw on the second brake handle using the last $\frac{1}{4}$ -20 Hex Nut.

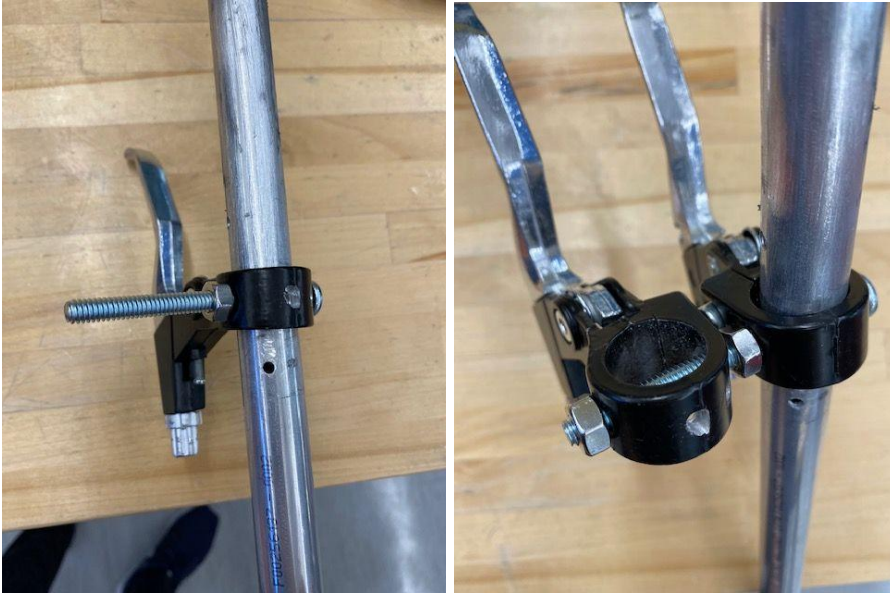

3. If the Brake Handle around the aluminum is loose, you can secure it using a 10mm wood screw attachment. First, drill a small hole for the wood screws. Then screw the wood screws into both the brake handle and the aluminum rod.
4. Attach the brake cables into the brake handles.
5. Tape the joystick from *3.4 Electronic Assembly Instructions* on top of the lever.

ASSEMBLY

Steering Mechanism:

1. Start with the frame subassembly.



2. Attach the tube part of the steering mechanism to the propulsion connection beam that you earlier removed from the frame subassembly by loosely attaching a t-nut to the hole in the tube part indicated below and then sliding the piece of 8020 over the t-nut as shown below.



3. Slide the 24" long piece of t-slot back into the frame subassembly, manipulating the tube part so that it goes underneath the footplate. Then slide a long $\frac{1}{4}$ -20 bolt through the hole in the tube part and the hole in the footplate and attach the two with a lock nut.

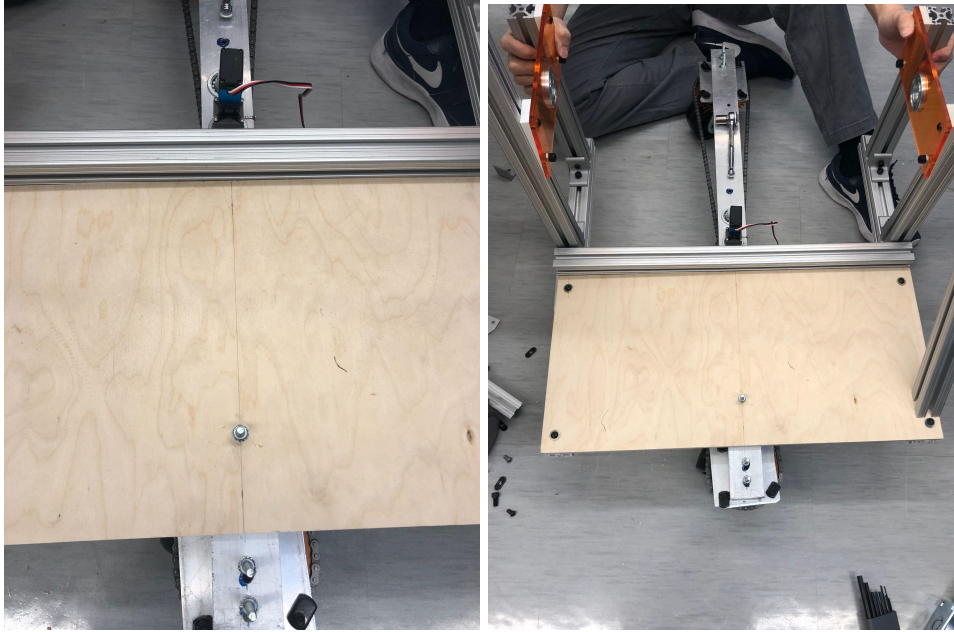

4. Then use L-brackets to attach the propulsion connection beam to the vertical handrail beams as shown below.

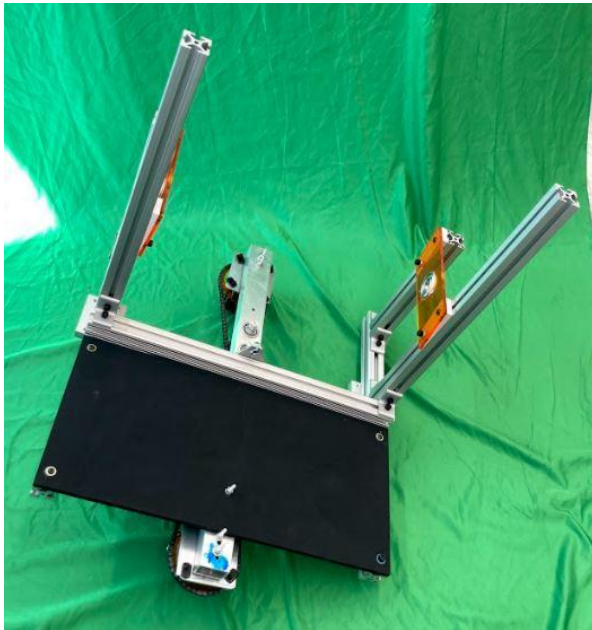

5. Slide the tube part around in the 8020 until it is parallel with both of the horizontal footplate supports and then tighten the t-nut. Then attach fixed caster wheels to their brackets and the assembly should look like this:

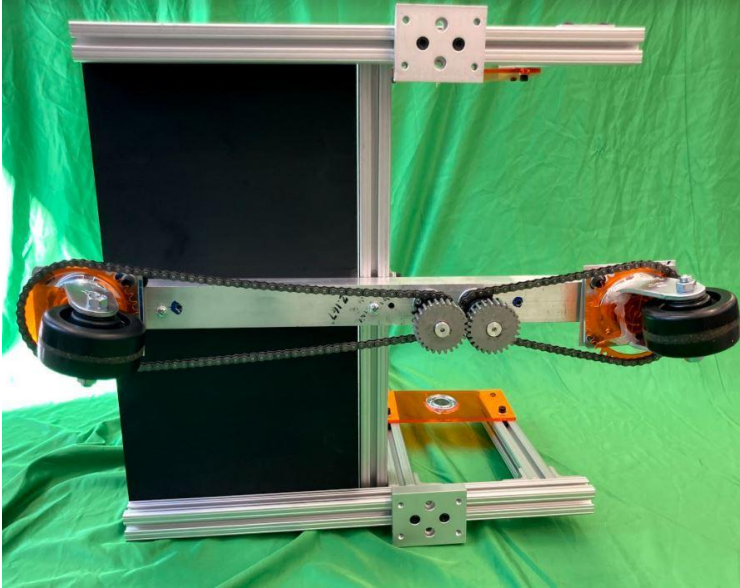

6. Attach the fixed caster brackets to the baseplates and then attach the fixed casters to the fixed caster brackets as shown below.

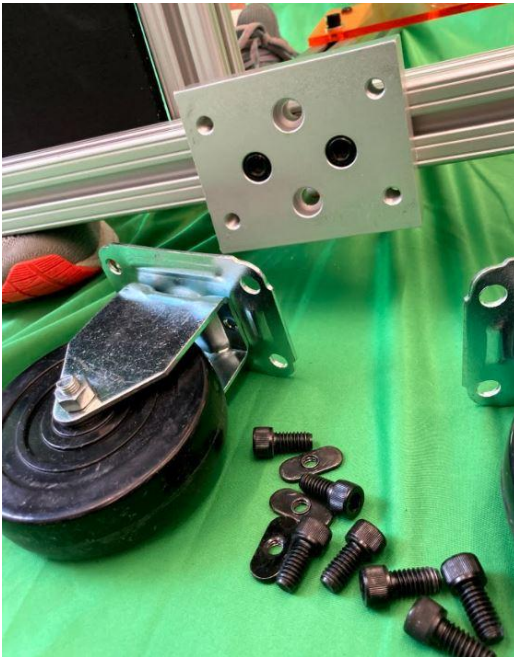

7. Tip the device up on its caster wheels and slide the brake subassembly t-nuts down the outside of the 24" long vertical t-slot (ignore the handrails in this picture, they should not be attached yet).

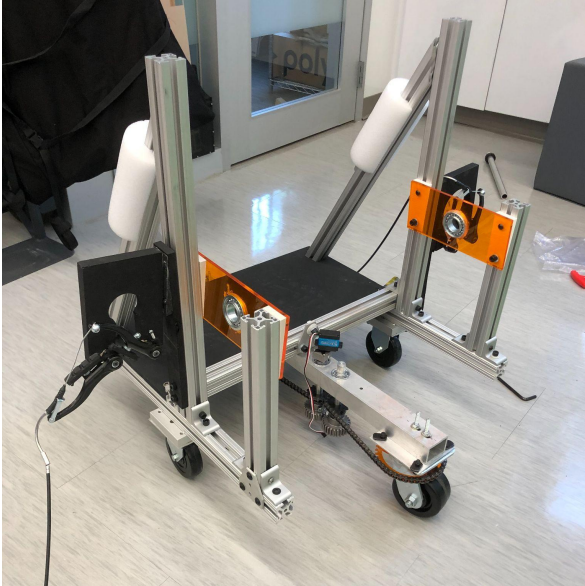

8. Attach the handrails to the 24" long vertical pieces of 8020 with t-brackets as shown below.

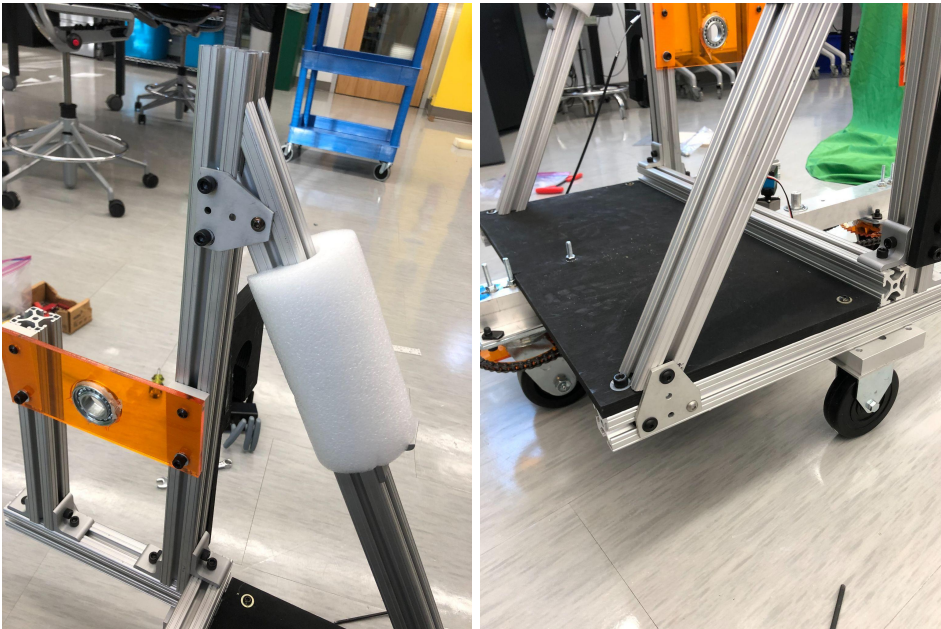

9. Attach the horizontal handrail beam with t-brackets as shown below.



10. Slide the vertical support beam down the t-nuts on the horizontal support beam L-bracket and in the horizontal footplate t-bracket.

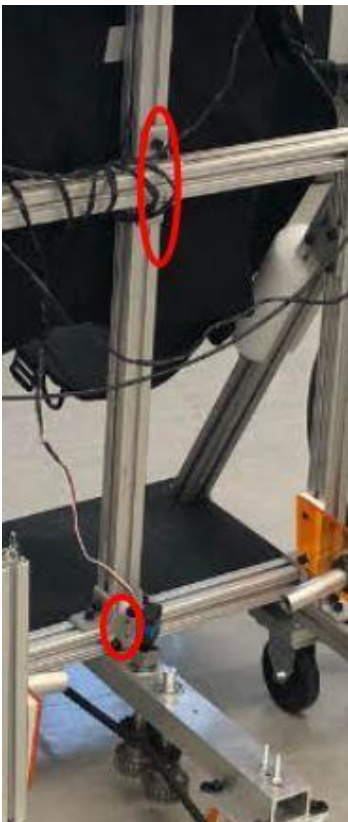

11. Use the L-brackets on the support beam to attach the vertical support beam to the propulsion connection beam.
12. Slide the first attachment bracket of the supports down the horizontal support beam. Wait to attach the second bracket to allow the tray to be secured without interference.



13. Put a shaft collar loosely on the axle and then slide the axle into the bearing in the Arch to Axle Bracket on each side as shown below.



14. Slide the tray down the vertical support beam and tighten the bolts in the L-brackets to secure it.



15. Now slide the second attachment bracket of the supports over the vertical support beam. Loosen the t-nut in the bottom support attachment bracket to adjust the height and then tighten both when desired height is reached.



16. Loosen brakes and slide them all the way up the t-slot to avoid interference and then tighten them again.
17. Slowly slide down the brakes subassembly and adjust the depth of the axle through the bearing until the brake fits over the wheel without interference. Then tighten the shaft collars of the wheel and the height of the brakes.



18. Attach the lever to the desired wheel by putting the spokes of the wheel through the slots in the lever. Attach the motor wiring. Attach the brake cables into the lever. The stander is complete!

